



INSERTABLES Y ESTUFAS  
*INSET & STOVES*



Instalaciones de más de 6000 m<sup>2</sup>, equipadas con las mejores tecnologías.  
*Facilities of more than 6000 m<sup>2</sup>, equipped with the best technologies*



## DESDE 1957, UNA EMPRESA EN CONSTANTE EVOLUCIÓN

67 años en el mercado, una de las empresas más longevas del sector.

Sin duda el éxito de CARBEL se debe al vínculo de confianza entre cliente, producto y empresa.

Nuestro objetivo ha sido siempre el de ofrecer a los clientes aparatos de calefacción a leña con unos elevados niveles de rendimiento, aportando soluciones competitivas y acordes a la realidad del mercado.

Con el carácter de nuestro fundador y caminando hacia el futuro.

Con el paso del tiempo, nuestros modelos han ido evolucionando hasta nuestro actual catálogo con más de 60 referencias, muestra de esta evolución es la creciente presencia de CARBEL a nivel nacional y nuestra expansión internacional.

Sin embargo, el carácter de nuestro fundador basado en la seriedad en el trabajo, junto con el trato directo y familiar con los clientes sigue tan arraigado en la empresa como el primer día.

## SINCE 1957, A COMPANY IN CONSTANT EVOLUTION

*67 years in the market makes us one of the longest standing companies in our sector.*

*CARBEL's success is the result of the trust that exists between our customers and our company.*

*Our goal has always been to offer our customers the most efficient wood heating stoves and provide the most competitive solutions.*

*Bearing values of our founder in mind, we focus on the future.*

*As time goes by, our models have evolved to our current range with more than 60 references. An evidence of our evolution is our growing presence in our national, and international markets.*

*However, the values of our founder, combining strong work ethics with direct and closerelationship with our customers are still at the heart of the company.*



Marcaje europeo  
*European requirement*

Norma  
Standard:  
EN 13240

Norma europea de referimiento para estufas de combustibles sólidos  
*European standard of reference for solid fuel stoves*

Norma  
Standard:  
EN 13229

Norma europea de referimiento para insertables de combustibles sólidos  
*European standard for solid fuel inset stoves*

Norma  
Standard:  
EN 16510

Equipos de calefacción residencial alimentados con combustible sólido  
*Residential solid fuel burning appliances.*



Productos que cumplen con la normativa alemana Stufe 2 BlmschV  
*Device compliant with German standard Stufe 2 BlmschV*



Miembro de la Asociación española de fabricantes de estufas, chimeneas y cocinas para combustibles sólidos  
*Member of the Spanish Association of solid fuel burning stove, fireplace and cooker manufacturers*



Norma  
Standard:  
15a B-VG

Productos que cumplen con la normativa austriaca 15a B-VG  
*Complian with Austrian standard*

Flamme verte

Productos que cumplen con la normativa francesa Flamme verte  
*Complian with French label*

Norma  
Standard:  
LRV Suisse

Productos que cumplen con la normativa suiza LRV Suisse  
*Complian with Swiss standard*



Productos que ya cumplen con la normativa ECODESIGN 2022  
*Ecodesign ready products*



## CARBEL, PRESENTE Y FUTURO DE UNA GRAN EMPRESA

Nuestra evolución y saber hacer a lo largo de estos 67 años se ven reflejados en nuestro equipo humano, nuestros procesos de fabricación, materiales y maquinaria que continuamente han ido mejorando en una clara apuesta por el futuro.

### Equipo humano

Sin duda, el principal activo de CARBEL es su equipo humano. Desde los departamentos de producción, investigación y desarrollo, administración y ventas; el cuidado en los procesos y la vocación hacia el cliente son las máximas.

### Instalaciones

Con unas instalaciones de más de 6000 m<sup>2</sup>, equipadas con las mejores tecnologías, desarrollamos íntegramente los procesos de diseño y fabricación de nuestros modelos. La automatización en la producción nos permite asegurar los mejores estándares de calidad que siempre han caracterizado a nuestros productos.

### Investigación y desarrollo

Nuestra oficina técnica, trabaja constantemente en la mejora y perfeccionamiento de la gama de productos con el fin de ofrecer soluciones fiables y competitivas. Disponemos de un laboratorio de ensayos que nos permite testar y perfeccionar nuestros modelos antes enviarlos a los laboratorios de certificación.

### Stock permanente

Conscientes de la importancia de satisfacer las necesidades de nuestros clientes en el momento adecuado, disponemos de un stock permanente de producto acabado.

## CARBEL, PRESENT AND FUTURE OF A GREAT FAMILY COMPANY

*Our development over the past 67 years is reflected in our staff, our manufacturing processes, materials and machinery that have been continuously improving as a clear commitment to the future.*

### Human team

*Without doubt, CARBEL's main asset is its staff. Production, R&D, administration and sales, they all share the same philosophy for excellence and care for the customer.*

### Facilities

*With facilities of more than 6000 m<sup>2</sup>, equipped with the latest technology, we have total control over the design and manufacturing processes. Our high level of automation ensures the best quality and consistency in all our products.*

### Research and development

*Our technical department works constantly to improve our product range in order to offer reliable and competitive solutions. We have our own laboratory to test and improve our products before sending them for certification.*

### Permanent stock

*Knowing how important it is to satisfy the needs of our customers quickly, we maintain a permanent stock of finished product.*

INSERTABLES - CASSETTES / INSETS



I-100



I-80



I-70



I-60



I-100 D.C. /  
DOUBLE-SIDED



I-80 D.C. /  
DOUBLE-SIDED

HOGARES / FIREPLACES



T2-100



T2-80



T2-70



G-100

SERIE RI Y ESTUFAS / RI SERIES AND STOVES



RI-100 LEÑERA /  
WITH LOG BOX



RI-80 LEÑERA /  
WITH LOG BOX



RI-70 LEÑERA /  
WITH LOG BOX



RI-60 LEÑERA /  
WITH LOG BOX



NOVEDAD

RI-100 PIE /  
FREE-STANDING



RI-80 PIE /  
FREE-STANDING



RI-70 PIE /  
FREE-STANDING



NOVEDAD

RI-100 D.C. /  
DOUBLE-SIDED



RI-80 D.C. /  
DOUBLE-SIDED



RA-100-2 SUSPENDIDO /  
SUSPENDED



NOVEDAD

RA-100-2 PIE /  
FREE-STANDING



RA-85-2 LEÑERA /  
WITH LOG BOX



ARES-2

ESTUFAS HORNO / STOVES WITH OVEN



ATLAS



ATLAS INSERTABLE /  
INSET



HERMES

ÍNDICE  
INDEX



I-70 D.C. /  
DOUBLE-SIDED



A-100-2



A-85-2



A-70-2



RI-100  
SUSPENDIDO /  
SUSPENDED



RI-80  
SUSPENDIDO /  
SUSPENDED



RI-70  
SUSPENDIDO /  
SUSPENDED



RI-60  
SUSPENDIDO /  
SUSPENDED



MAIA  
CUBE



MAIA  
LARGE



MAIA  
ROUND



MAIA  
WALL



ATENEA

**INSERTABLES - CASSETTES**

**INSETS**

I-100 .....	8
I-80 .....	9
I-70 .....	10
I-60 .....	11
I-100 Doble Cara / Double-sided .....	12
I-80 Doble Cara / Double-sided .....	13
I-70 Doble Cara / Double-sided .....	13
A-100-2 .....	20
A-85-2 .....	21
A-70-2 .....	21

**HOGARES**

**FIREPLACES**

T2-100 .....	16
T2-80 .....	17
T2-70 .....	18
G-100 .....	22

**SERIE RI Y ESTUFAS**

**RI SERIES & FREESTANDING STOVES**

RI-100 .....	24
RI-80 .....	25
RI-70 .....	25
RI-60 .....	25
RI-100 Suspendedo / Suspended .....	24
RI-80 Suspendedo / Suspended .....	25
RI-70 Suspendedo / Suspended .....	25
RI-60 Suspendedo / Suspended .....	25
RI-100 Leñera / With log box .....	24
RI-80 Leñera / With log box .....	25
RI-70 Leñera / With log box .....	25
RI-60 Leñera / With log box .....	25
RI-100 Doble Cara / Double-sided .....	26
RI-80 Doble Cara / Double-sided .....	26
RA-100-2 Suspendedo / Suspended .....	28
RA-100-2 Pie / Free-standing .....	28
RA-85-2 Leñera / With log box .....	29
ARES-2 .....	30
MAIA ROUND .....	32
MAIA LARGE .....	33
MAIA WALL .....	33
MAIA CUBE .....	34
ATENEA .....	35

**ESTUFAS CON HORNO**

**STOVES WITH OVEN**

ATLAS .....	36
ATLAS Insertable / Inset .....	38
HERMES .....	40

# LA OFERTA EN INSERTABLES Y HOGARES MÁS COMPLETA

## A COMPLETE OFFER IN INSETS AND FIREPLACES



### SERIE I Versiones frontal y doble cara

#### La referencia en casetes insertables

#### *The inset's reference*

- Ideales para la renovación de una vieja chimenea o para obra nueva.
- Rendimientos entre el 79% y el 87%.
- Disponibles en tamaños de 60, 70, 80 y 100 cm
- Incluyen sistema de ventilación mediante ventiladores axiales.
- Permiten la canalización de aire caliente.
- Incluyen cajón cenicero (excepto I-60).
- Entrada de aire exterior opcional para la combustión.
- Amplia variedad de marcos a elegir.
- Dos opciones para el revestimiento de la cámara de combustión.

- *Ideal to renew existing fireplaces or for new installations.*
- *Efficiency between 79% and 87%.*
- *Available in widths of 60, 70, 80 and 100 cm.*
- *Axial fans included.*
- *Possibility to channel hot air to other rooms.*
- *Ash pan included (except I-60).*
- *Optional external air intake.*
- *A broad range of frames to choose.*
- *Two options for the interior lining.*



### SERIE A-2

#### Insertables con visión lateral a dos o tres cristales

#### *A range of inserts two or three side glasses*

- Disponibles en tamaños de 100, 85, y 70 cm.
- Ideales para crear dos o tres ambientes gracias a su visión lateral.
- Disponen de 2 salidas para la canalización del aire caliente.
- Entrada de aire exterior opcional para la combustión.
- Puerta reversible, posibilidad de apertura a derecha o izquierda.

- *Available in widths of 100, 85 or 70 cm.*
- *The best option to create warm areas.*
- *Includes 2 outlets for channelling hot air.*
- *Optional exterior air intake.*
- *Reversible door, possibility to have the opening on the right or on the left.*

## SERIE T2

### Hogares panorámicos

#### *Panoramic fireplaces*

- Ideales para obra nueva.
- Disponibles en tamaños de 70, 80 y 100 cm.
- No incluyen ventilación de serie.
- Cristal panorámico.
- Entrada de aire exterior opcional para la combustión.
- Ventilación opcional mediante potente y silenciosa turbina con opción de centralita y mando a distancia.
- Permite la canalización de aire caliente a otras habitaciones a mayor distancia.
- Amplia variedad de marcos a elegir.
- Entrada de aire para convección.
  
- *The best option for new installations .*
- *Available in widths of 70, 80 or 100 cm.*
- *Without fans.*
- *Panoramic glass.*
- *Optional exterior air intake.*
- *Optional ventilation system with a powerful and silent turbine with remote control.*
- *Possibility to channel hot air to other rooms.*
- *A broad range of frames to choose from.*
- *Convection air entry.*



## SERIE RI

### Listos para instalar: disponibles en una cara, dos y hasta tres caras

#### *Ready to install: available in one side, double or three sided*

- Disponibles en tamaños de 100, 80, 70 y 60 cm.
- Su diseño le permitirá disfrutar del calor por radiación, mientras que sus ventiladores integrados acelerarán la aportación de calor por convección.
- Gran cámara de combustión.
- Entrada de aire exterior opcional para la combustión.
  
- *Available in widths of 100, 80, 70 or 60 cm.*
- *The design will allow you to enjoy the radiant heat as well as the additional convection warmth from its installed fans.*
- *Large combustion chamber.*
- *Optional exterior air intake.*



# PERSONALICE SU PROPIO CASSETTE INSERTABLE *CUSTOMIZE YOUR OWN INSET*

## PERSONALICE EL REVESTIMIENTO INTERIOR *CUSTOMIZE THE INTERIOR LINING OF YOUR INSET*



Rendimiento  
*Performance*  
★★★★★

Resistencia  
*Strength*  
★★★★★

Respuesta térmica  
*Thermal response*  
★★★★★

### THERMIC

Interior revestido con placas refractarias que ayudan a obtener una mejor combustión. Material autolimpiante.

*Interior lined with refractory slabs for a better combustion. Self-cleaning material.*



Rendimiento  
*Performance*  
★★★★★

Resistencia  
*Strength*  
★★★★★

Respuesta térmica  
*Thermal response*  
★★★★★

### VERMICULITA / VERMICULITE

Interior revestido con placas de Vermiculita. Gracias a sus propiedades refractarias se consiguen temperaturas más elevadas, favoreciendo la combustión de la leña.

*Interior lined with Vermiculite sheets. Their refractory properties offer higher temperatures, improving the combustion.*

## PERSONALICE LAS DIMENSIONES Y ESTILOS DEL MARCO *CUSTOMIZE THE FRAME SIZE AND STYLE*



Marco 4 lados, 2,5 cm.  
*4-sided frame, 2,5 cm.*



Marco 3 lados, 4,5 cm.  
*3-sided frame, 4,5 cm.*



Marco 4 lados, 4,5 cm.  
*4-sided frame, 4,5 cm.*



Marco CRISTAL  
*GLASS frame*





## POR UN MEDIOAMBIENTE MEJOR, SOLO EQUIPOS ECODESIGN

El 1 de enero 2022 entró en vigor en toda Europa la normativa de obligatorio cumplimiento Ecodesign, una nueva regulación, que obliga a los fabricantes y vendedores de equipos de combustibles sólidos a comercializar e instalar solo productos que cumplan con sus criterios:

- Rendimientos energéticos mayores.
- Niveles de emisiones más bajos.

### ¿Qué beneficios tiene esta norma para el consumidor?

- Mayor ahorro en combustible.
- Respeto por el medio ambiente.
- Mejora y protección de la calidad del aire.

### ¿Cómo reconozco un producto Ecodesign?

El compromiso de **Carbel** con el medio ambiente es ofrecer todo un catálogo de productos acorde a la normativa, podrás distinguirlos gracias a su sello:

## FOR A BETTER ENVIRONMENT, ONLY ECODESIGN DEVICES

*The 1<sup>st</sup>. January 2022, the Ecodesign regulation was applied on all stoves and fireplaces throughout Europe. Ecodesign is a new regulation that obliges manufacturers and sellers of solid fuel equipment to market and install only products that meet this new standard based on:*

- *Higher energy efficiencies.*
- *Lower levels of emissions.*

### *What benefits does EcoDesign have for the consumer?*

- *Lower consumption of wood.*
- *Respect for the environment.*
- *Air quality protection and improvement.*

### *How do I recognize an Ecodesign product?*

*Carbel's commitment to the environment is to offer a whole catalogue of products in accordance with the regulations. You can distinguish them thanks to the seal:*



Por el futuro de todos, exige productos Ecodesign.  
*For the future of all, demand Ecodesign products.*

# I-100

## La gama de insertables con más prestaciones *The range of cassettes with outstanding performances*

- Sistema de regulación de la salida de aire caliente frontal.
- Entrada de aire exterior opcional para la combustión.
- Sistema de ventiladores de dos velocidades y termostato de seguridad.
- Incluye cajón cenicero.
- Puerta reversible y reforzada.
- *Front air outlet adjustment system.*
- *Optional exterior air intake.*
- *Ventilation through two-speed fans and safety thermostat.*
- *Ash pan included.*
- *Reinforced and reversible door.*



### I-100

- Rendimiento 87,3%.
- Dispone de 4 ventiladores y 4 salidas para la canalización del aire caliente.
- Gran cámara de combustión en Vermiculita o Thermic.
- *Efficiency rate of 87,3%.*
- *Equipped with 4 fans and 4 outlets for channelling hot air.*
- *Large combustion chamber available in Vermiculite or Thermic.*

A+



# I-80

## La gama de insertables con más prestaciones *The range of cassettes with outstanding performances*

- Sistema de regulación de la salida de aire caliente frontal.
  - Entrada de aire exterior opcional para la combustión.
  - Sistema de ventiladores de dos velocidades y termostato de seguridad.
  - Incluye cajón cenicero.
  - Puerta reversible y reforzada.
- *Front air outlet adjustment system.*
  - *Optional exterior air intake.*
  - *Ventilation through two-speed fans and safety thermostat.*
  - *Ash pan included.*
  - *Reinforced and reversible door.*



### I-80

- Rendimiento 85,09%.
  - Dispone de 2 ventiladores y 4 salidas para la canalización del aire caliente.
  - Gran cámara de combustión en Vermiculita o Thermic.
- *Efficiency rate of 85,09%.*
  - *Includes 2 fans and 4 outlets for channelling hot air.*
  - *Large combustion chamber available in Vermiculite or Thermic.*



# I-70

## La gama de insertables con más prestaciones *The range of cassettes with outstanding performances*

- Sistema de regulación de la salida de aire caliente frontal.
- Entrada de aire exterior opcional para la combustión.
- Sistema de ventiladores de dos velocidades y termostato de seguridad.
- Incluye cajón cenicero.
- Puerta reversible y reforzada.
- *Front air outlet adjustment system.*
- *Optional exterior air intake.*
- *Ventilation through two-speed fans and safety thermostat.*
- *Ash pan included.*
- *Reinforced and reversible door.*



### I-70

- Rendimiento 85,09%.
- Dispone de 2 ventiladores y 2 salidas para la canalización del aire caliente.
- Gran cámara de combustión en Vermiculita o Thermic.
- *Efficiency rate of 85,09%.*
- *Includes 2 fans and 2 outlets for channelling hot air.*
- *Large combustion chamber available in Vermiculite or Thermic.*

A+



# I-60

## La gama de insertables con más prestaciones *The range of cassettes with outstanding performances*

- Sistema de regulación de la salida de aire caliente frontal.
- Entrada de aire exterior opcional para la combustión.
- Sistema de ventiladores de dos velocidades y termostato de seguridad.
- Puerta reversible y reforzada.
- *Front air outlet adjustment system.*
- *Optional exterior air intake.*
- *Ventilation through two-speed fans and safety thermostat.*
- *Reinforced and reversible door.*



### I-60

- Rendimiento 81%.
- Dispone de 2 ventiladores y 2 salidas para la canalización del aire caliente.
- Gran cámara de combustión en Vermiculita o Thermic.

- *Efficiency rate of 81%.*
- *Includes 2 fans and 2 outlets for channelling hot air.*
- *Large combustion chamber available in Vermiculite or Thermic.*

A+



INSERTABLE / INSET

## I-100 DOBLE CARA / DOUBLE-SIDED

Las mejores prestaciones y visión del fuego  
*Better performances and view of the fire*

- Disponible en tamaños de 100, 80, y 70 cm.
  - Sistema de ventilación por ambos lados mediante 4 ventiladores de dos velocidades y termostato de seguridad.
  - Entrada de aire exterior opcional para la combustión.
  - Sistema de regulación de la salida de aire caliente frontal.
  - Puerta reversible y reforzada.
- Available in widths of 100, 80 or 70 cm.
  - Ventilation system at both sides, with 4 two-speed fans and safety thermostat.
  - Optional exterior air intake.
  - Front air outlet adjustment system.
  - Reinforced and reversible door.



### I-100 DOBLE CARA / DOUBLE-SIDED

- Rendimiento 78%.
  - Dispone de 4 ventiladores y 2 salidas para la canalización del aire caliente.
  - Cámara de combustión en Vermiculita.
- Efficiency rate of 78%.
  - Includes 4 fans and 2 outlets for channelling hot air.
  - Interior lining in Vermiculite.

A



15a B-VG  
LRV

# I-80 / I-70 DOBLE CARA / DOUBLE-SIDED

Las mejores prestaciones y visión del fuego  
*Better performances and view of the fire*

- Disponible en tamaños de 100, 80, y 70 cm.
  - Sistema de ventilación por ambos lados mediante 4 ventiladores de dos velocidades y termostato de seguridad.
  - Entrada de aire exterior opcional para la combustión.
  - Sistema de regulación de la salida de aire caliente frontal.
  - Puerta reversible y reforzada.
- Available in widths of 100, 80 or 70 cm.
  - Ventilation system at both sides, with 4 two-speed fans and safety thermostat.
  - Optional exterior air intake.
  - Front air outlet adjustment system.
  - Reinforced and reversible door.



## I-80, I-70 DOBLE CARA / DOUBLE-SIDED

- Rendimiento I-80 78% / I-70 82%.
  - Dispone de 4 ventiladores y 2 salidas para la canalización del aire caliente.
  - Cámara de combustión en Vermiculita.
- Efficiency rate of I-80 78% / I-70 82%.
  - Includes 4 fans and 2 outlets for channelling hot air.
  - Interior lining in Vermiculite.

A+

A



15a B-VG  
LRV

## Características y opciones de personalización *Features and customization options*

### OPCIONES DE REVESTIMIENTO PARA LA CÁMARA DE COMBUSTIÓN *CUSTOMIZE THE INTERIOR LINING OF YOUR FIREPLACE*



#### **THERMIC**

Interior revestido con placas refractarias que ayudan a obtener una mejor combustión. Material autolimpiante.

*Interior lined with refractory slabs for a better combustion. Self-cleaning material.*

Excepto modelos de doble cara.  
*Except double-sided models.*

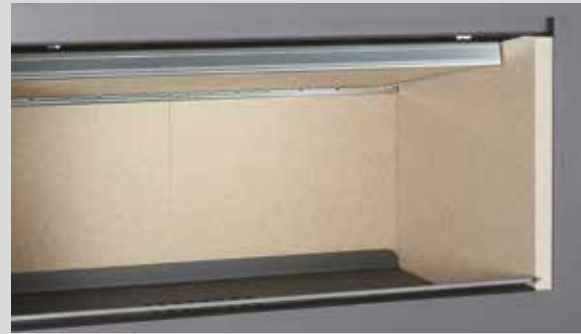

#### **VERMICULITA / VERMICULITE**

Interior revestido con placas de Vermiculita. Gracias a sus propiedades refractarias se consiguen temperaturas más elevadas, favoreciendo la combustión de la leña.

*Interior lined with Vermiculite sheets. Their refractory properties offer higher temperatures, improving the combustion.*

### EL CUIDADO DE LOS DETALLES MARCA LA DIFERENCIA *THE DETAILS MAKE THE DIFFERENCE*



Cristales serigrafiados que realzan el diseño del producto. Líneas modernas, sencillas y estilizadas. Calidad en los materiales y en la concepción del producto.

*Screen printed glass makes the design of the product stand out. Modern, simple and stylish lines. High quality materials.*



#### **Clapeta frontal de regulación de aire**

Regulación frontal que permite abrir o cerrar la salida de aire, permitiendo redirigir mayor calor a las habitaciones en caso de que se canalice.

#### **Frontal flap for air regulation**

Frontal regulation for opening and closing the convection air outlet, in order to increase the air flow to other rooms.



#### **Máximo control en la combustión**

Entradas de aire primario y secundario regulables.

#### **Maximum control of the combustion**

*Adjustable primary and secondary air intakes.*



## Características y opciones de personalización *Features and customization options*

### OPCIONES DE MARCO FRAME OPTIONS

Marco CRISTAL  
*GLASS frame*

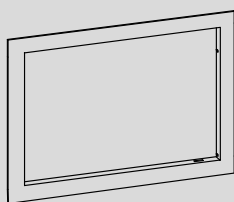

**MODELOS / MODELS**

I-100 / T2-100  
I-80 / T2-80  
I-70 / T2-70  
I-100 Doble cara / *Double-sided*  
I-80 Doble cara / *Double-sided*  
I-70 Doble cara / *Double-sided*

Marco 3 lados, 4,5 cm.  
*3 sided frame, 4,5 cm.*

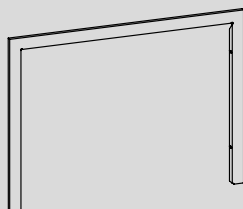

**MODELOS / MODELS**

I-100 / T2-100  
I-80 / T2-80  
I-70 / T2-70  
I-60  
I-100 Doble cara / *Double-sided*  
I-80 Doble cara / *Double-sided*  
I-70 Doble cara / *Double-sided*

Marco 4 lados, 2,5 cm.  
*4 sided frame, 2,5 cm.*

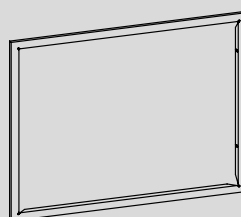

**MODELOS / MODELS**

I-100 / T2-100  
I-80 / T2-80  
I-70 / T2-70  
I-60  
I-100 Doble cara / *Double-sided*  
I-80 Doble cara / *Double-sided*  
I-70 Doble cara / *Double-sided*

Marco 4 lados, 4,5 cm.  
*4 sided frame, 4,5 cm.*

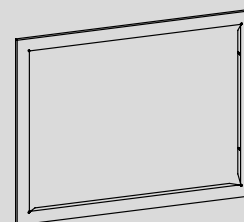

**MODELOS / MODELS**

I-100 / T2-100  
I-80 / T2-80  
I-70 / T2-70  
I-60  
I-100 Doble cara / *Double-sided*  
I-80 Doble cara / *Double-sided*  
I-70 Doble cara / *Double-sided*

### CÁMARA DE COMBUSTIÓN INTERIOR LINING



OPCIONAL - Juego de patas regulables.  
Amplia cámara de combustión.

*OPTIONAL - Adjustable leg set.  
Large combustion chamber.*

# T2-100

Ideales para canalizar a larga distancia  
*The perfect choice for air distribution*

- Disponibles en tamaños de 100, 80, y 70 cm.
- Entrada de aire exterior para la combustión.
- Sin ventilación de serie.
- Opcional turbina eco silent con centralita y mando a distancia o Box 430.
- Puerta reversible y reforzada.
- Available in widths of 100, 80 or 70 cm.
- Exterior air intake.
- Without ventilation as standard.
- Optional Ecosilent turbine with control unit and remote control or Box 430.
- Reinforced and reversible door.



Opcional turbina Eco Silent con centralita y mando a distancia  
*Optional Eco Silent turbine with control module and remote*



Opción de marcos personalizables.  
*Optional customizable frames.*

## T2-100

- Rendimiento 87,3%.
- Ideal para canalizar a otras habitaciones.
- Gran cámara de combustión en Vermiculita.
- Efficiency rate of 87,3%.
- The best option to channel the air to other rooms.
- Interior lining in Vermiculite.



# T2-80

La gama T ofrece las mejores prestaciones y rendimientos  
*The T range offers the best performance and efficiency*

- Disponibles en tamaños de 100, 80, y 70 cm.
  - Entrada de aire exterior para la combustión.
  - Sin ventilación de serie.
  - Opcional turbina eco silent con centralita y mando a distancia o Box 430.
  - Puerta reversible y reforzada.
- Available in widths of 100, 80 or 70 cm.
  - Exterior air intake.
  - Without ventilation as standard.
  - Optional Ecosilent turbine with control unit and remote control or Box 430.
  - Reinforced and reversible door.



## T2-80

- Rendimiento 85,09%.
  - Ideal para canalizar a otras habitaciones.
  - Gran cámara de combustión en Vermiculita.
- Efficiency rate of 85,09%.
  - The best option to channel the air to other rooms.
  - Interior lining in Vermiculite.



# T2-70

## Gran cámara de combustión y cristal panorámico *Large combustion chamber and panoramic glass*

- Disponibles en tamaños de 100, 80, y 70 cm.
- Entrada de aire exterior para la combustión.
- Sin ventilación de serie.
- Opcional turbina eco silent con centralita y mando a distancia o Box 430.
- Puerta reversible y reforzada.
- Available in widths of 100, 80 or 70 cm.
- Exterior air intake.
- Without ventilation as standard.
- Optional Ecosilent turbine with control unit and remote control or Box 430.
- Reinforced and reversible door.



### T2-70

- Rendimiento 85,09%.
- Ideal para canalizar a otras habitaciones.
- Gran cámara de combustión en Vermiculita.
- Efficiency rate of 85,09%.
- The best option to channel the air to other rooms.
- Interior lining in Vermiculite.

A+



GAMA T2  
T2 RANGE

## Características y opciones de personalización *Features and customization options*

### CÁMARA DE COMBUSTIÓN / INTERIOR LINING



OPCIONAL - Juego de patas regulables.  
Amplia cámara de combustión.

*OPTIONAL - Adjustable leg set.  
Large combustion chamber.*

### OPCIONES DE VENTILACIÓN GAMA T2 T2 RANGE VENTILATION OPTIONS

**1** - Convección natural (sin turbina).  
*Natural convection (without fans).*



**2** - Turbina ECO SILENT con centralita y mando a distancia.  
*ECO SILENT turbine with control module and remote control.*



**3** - Box ECO SILENT con centralita y mando a distancia.  
*ECO SILENT box with control module and remote control.*

### OPCIONES DE MARCO FRAME OPTIONS

Marco CRISTAL  
*GLASS frame*

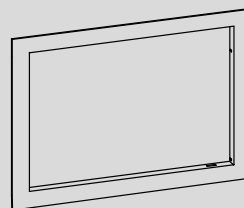

4 lados, 4,5 cm.  
*4 sided, 4,5 cm.*

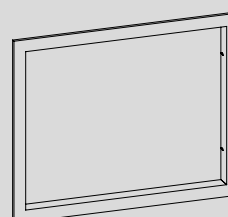

3 lados, 4,5 cm.  
*3 sided, 4,5 cm.*

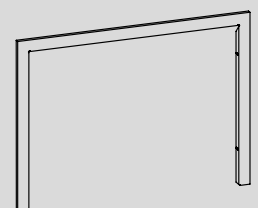

4 lados, 2,5 cm.  
*4 sided, 2,5 cm.*

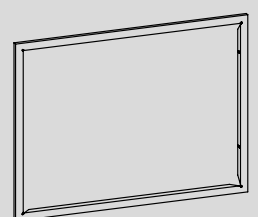

INSERTABLE / INSET

# A-100-2, A-85-2 y A-70-2

Insertables con visión lateral a dos o tres cristales

*A range of inserts two or three side glasses*

- Disponibles en tamaños de 100, 85, y 70 cm.
- Ideales para crear dos o tres ambientes gracias a su visión lateral.
- Disponen de 2 salidas para la canalización del aire caliente.
- Entrada de aire exterior opcional para la combustión.
- Puerta reversible, posibilidad de apertura a derecha o izquierda.
- Available in widths of 100, 85 or 70 cm.
- The best option to create warm areas.
- Includes 2 outlets for channelling hot air.
- Optional exterior air intake.
- Reversible door, possibility to have the opening on the right or on the left.



## A-100-2

- Rendimiento 78%.
- Ventilación mediante cuatro ventiladores de dos velocidades y termostato de seguridad.
- Cámara de combustión de Thermic.
- Efficiency rate of 78%.
- Ventilation by means of four 2-speed fans and safety thermostat.
- Interior lining in Thermic.

A





**A-85-2 / A-70-2**

- Rendimiento 75%.
- Ventilación de mediante dos ventiladores de dos velocidades y termostato de seguridad.
- Cámara de combustión de Thermic.

- Efficiency rate of 75%.
- Ventilation by means of four 2-speed fans and safety thermostat.
- Interior lining in Thermic.



**CÁMARA DE COMBUSTIÓN DE THERMIC  
COMBUSTION CHAMBER IN THERMIC**

Interior revestido con placas refractarias que ayudan a obtener una mejor combustión. Material autolimpiante.

*Interior lined with refractory slabs for a better combustion. Self-cleaning material.*

**OPCIONES DE MARCO  
FRAME OPTIONS**

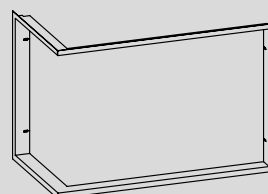

- Marco 4 lados, 2,5 cm. Para cristal a dos caras, a derecha o izquierda
- 4 sided, 2,5 cm. frame. For two glasses, right or left

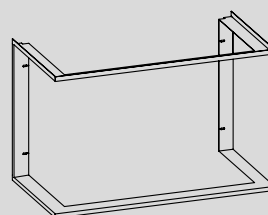

- Marco 4 lados, 2,5 cm. Para cristal a tres caras
- 4 sided, 2,5 cm. frame. For three sides glasses

# G-100

## Modelo guillotina, tecnología y diseño *Model with lift-up door, technology and design*

- Hogar panorámico de 100 cm. con puerta guillotina.
- Opcional Box Eco silent, potente y muy silencioso con centralita y mando a distancia.
- Entrada de aire exterior para la combustión.
- Entrada de aire para la convección.
- *Panoramic one meter wide insert stove with a lifting door.*
- *Optional Eco silent Box, powerful and very silent with control module and remote control.*
- *Exterior air inlet for combustion air.*
- *Convection air outlets.*



### G-100

- Rendimiento 76%.
- Dispone de 4 salidas para la canalización del aire caliente.
- Cámara de combustión de Thermic.

- *Efficiency rate of 76%.*
- *Includes 4 outlets for channelling hot air.*
- *Interior lining in Thermic.*

A





G-100

## Características y opciones *Features and options*



Puerta deslizante y abatible. Amplio cristal serigrafiado.

*Sliding and hinged door. Wide screen printed window.*



Puerta de apertura lateral. Facilita la limpieza del cristal.

*Hinged door opening sideways. Allows the cleaning of the glass.*



Cámara de combustión de THERMIC. Mayor inercia térmica y resistencia.

*Combustion chamber in THERMIC. High level of thermal inertia and strength.*



Monomando. Permite controlar el aire de combustión primario y secundario.

*Single control. Allows control of primary and secondary combustion air.*



Dispone de toma de aire de combustión canalizable del exterior. De manera independiente otra toma de aire permite la entrada del aire de convección.

*Equipped with an exterior air inlet for combustion air. A different inlet allows the entrance of convection air.*



Canalizable. Dotado de 4 salidas para canalizar el aire caliente.

*Prepared for hot air ducts. 4 outlets for the channelling of hot air to other rooms.*



### **BOX ECO SILENT CON CENTRALITA Y MANDO A DISTANCIA**

Opcional sistema de ventilación independiente potente y silencioso.

### **ECO SILENT BOX WITH CONTROL MODULE AND REMOTE CONTROL**

*Optional fan system, powerful and silent.*

# RI

## Las estufas con mayor cámara de combustión *The stoves with the biggest combustion chamber*

- Disponibles en tamaños de 100, 80, 70 y 60 cm.
- Su diseño le permitirá disfrutar del calor por radiación, mientras que sus ventiladores integrados acelerarán la aportación de calor por convección.
- Gran cámara de combustión.
- Entrada de aire exterior opcional para la combustión.
- Available in widths of 100, 80, 70 or 60 cm.
- The design will allow you to enjoy the radiant heat as well as the additional convection warmth from its installed fans.
- Large combustion chamber.
- Optional exterior air intake.



### RI-100 (Opción suspendido a la pared / Wall-suspended option)

- Rendimiento 87,3%.
- Dispone de 4 ventiladores.
- Cámara de combustión en Vermiculita o Thermic.
- Disponible para los modelos RI-100, RI-80, RI-70 y RI-60.
- Efficiency rate of 87,3 %.
- Equipped with 4 fans.
- Combustion chamber available in Vermiculite or Thermic.
- Available for models RI-100, RI-80, RI-70 and RI-60.

A+



**NUEVO DISEÑO**

**Pie ovalado**



**RI-80, RI-70 (Opción sobre pie / Free-standing)**

- Rendimiento 85,09%.
- Dispone de 2 ventiladores.
- Cámara de combustión en Vermiculita o Thermic.
- Disponible para los modelos RI-100, RI-80 y RI-70.

- Efficiency rate of 85,09%.
- Equipped with 2 fans.
- Combustion chamber available in Vermiculite or Thermic.
- Available for models RI-100, RI-80 and RI-70.



**RI-60 (Opción sobre leñera / Supported on log store)**

- Rendimiento 81%.
- Dispone de 2 ventiladores.
- Cámara de combustión en Vermiculita o Thermic.

- Efficiency rate of 81 %.
- Equipped with 2 fans.
- Combustion chamber available in Vermiculite or Thermic.



## RI DOBLE CARA / DOUBLE-SIDED

Estufas de doble cara, ahora con mayor visión del fuego  
*Double sided stoves, for a better view of the fire*

- Disponibles en tamaños de 100 y 80 cm.
- Diseños a doble cara, ideales para separar ambientes y disfrutar del espectáculo del fuego.
- Sistema de ventilación por ambos lados mediante cuatro ventiladores.
- Mejorado sistema de cristal limpio.
- Available in widths of 100 or 80 cm.
- Double-sided design, ideal for separating different areas, and enjoying the fire from both.
- Ventilation system on both sides by means of four fans.
- Air wash system.

**NUEVO DISEÑO**

Pie ovalado



### RI-100, RI-80 DOBLE CARA / DOUBLE-SIDED

- Rendimiento 78%.
- Sistema de ventilación por ambos lados mediante cuatro ventiladores.
- Cámara de combustión en Vermiculita.
- Efficiency rate of 78%.
- Ventilation system on both sides through four fans.
- Interior lining in Vermiculite.

A



15a B-VG  
LRV

SERIE RI  
RI SERIES

## Características y opciones de personalización *Features and customization options*

### OPCIONES DE INTERIOR / INTERIOR OPTIONS



#### VERMICULITA / VERMICULITE

Interior revestido con placas de Vermiculita. Gracias a sus propiedades refractarias se consiguen temperaturas más elevadas, favoreciendo la combustión de la leña.

*Interior lined with Vermiculite sheets. Their refractory properties offer higher temperatures, improving the combustion.*



#### THERMIC

Interior revestido con placas refractarias que ayudan a obtener una mejor combustión. Material autolimpiante. (Opcional para versiones de una cara: RI-100, RI-80, RI-70 y RI-60)

*Interior lined with refractory slabs for a better combustion. Self-cleaning material. (Optional for one-sided versions: RI-100, RI-80, RI-70 and RI-60)*

### OPCIONES PERSONALIZACIÓN / CUSTOMIZATION OPTIONS

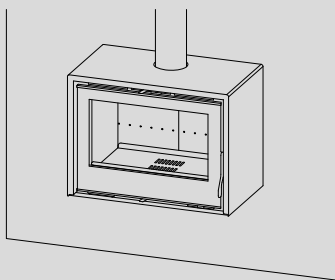

#### Suspendido a la pared *Wall-suspended*

RI-100  
RI-80  
RI-70  
RI-60

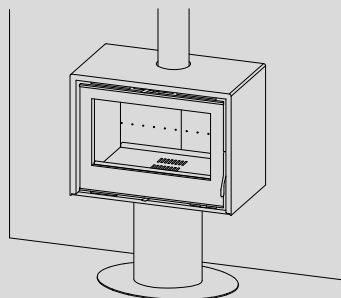

#### Sobre pie *Free-standing*

RI-100  
RI-80  
RI-70  
RI-100 Doble cara/  
*Double-sided*  
RI-80 Doble cara/  
*Double-sided*

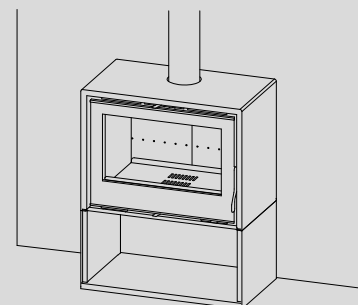

#### Sobre leñera *Supported on log store*

RI-100  
RI-80  
RI-70  
RI-60

# RA-100-2 y RA-85-2

## Estufas a tres cristales

### Stove with three-sided glasses

- Disfrutará al máximo gracias a su visión del fuego a través de sus tres caras acristaladas.
- Su diseño tipo estufa le permitirá simplificar la instalación.
- Múltiples opciones de montaje.
- Puerta reversible, posibilidad de apertura a derecha o izquierda.
- *The best way to enjoy the fire.*
- *For an easy installation.*
- *Multiple installation options.*
- *Reversible door, possibility to have the opening on the right or on the left.*



Nueva maneta cromada y cantonera negra.  
*New chromed handle and black corners.*

RA-100-2 sobre pie  
*RA-100-2 free-standing*

#### RA-100-2 (Opción suspendido a la pared / Wall-suspended)

- Rendimiento 78%.
- Ventilación mediante cuatro ventiladores de dos velocidades y termostato de seguridad.
- Cámara de combustión de Thermic.
- *Efficiency rate of 78%.*
- *Ventilation by means of four 2-speed fans and safety thermostat.*
- *Interior lining in Thermic.*

A





**RA-85-2 (Opción sobre leñera / Log store option)**

- Rendimiento 75%.
- Ventilación mediante dos ventiladores de dos velocidades y termostato de seguridad.
- Cámara de combustión de Thermic.

- *Efficiency rate of 75%.*
- *Ventilation by means of two 2-speed fans and safety thermostat.*
- *Interior lining in Thermic.*



**CÁMARA DE CONBUSTIÓN DE THERMIC  
COMBUSTION CHAMBER IN THERMIC**

Interior revestido con placas refractarias que ayudan a obtener una mejor combustión. Material autolimpiante.

*Interior lined with refractory slabs for a better combustion. Self-cleaning material.*

# ARES-2

## La estufa eficiente *The highly efficient stove*

- Rendimiento mejorado.
- Cristal panorámico para una inmejorable visión de fuego.
- Amplia cámara de combustión con un ancho útil de más de 50 cm.
- Entrada de aire exterior opcional para la combustión.
- Mayor cámara de combustión.
- *Improved efficiency.*
- *Panoramic glass that offers an unbeatable view of the fire.*
- *Large combustion chamber, with a useable width of over 50 cm.*
- *Optional exterior air intake.*
- *Larger combustion chamber.*



### ARES-2

- Rendimiento 85,09%.
- Cámara de combustión de Thermic.
- Opcional tapa superior en cristal.
- *Efficiency rate of 85,09%.*
- *Interior lining in Thermic.*
- *Optional top glass.*

A+





ARES-2

## Características y opciones de personalización

### *Features and customization options*



#### **CÁMARA DE CONBUSTIÓN DE THERMIC** **COMBUSTION CHAMBER IN THERMIC**

Mayor cámara de combustión.

Interior revestido con placas refractarias que ayudan a obtener una mejor combustión. Material autolimpiante..

*Larger combustion chamber*

*Interior lined with refractory slabs for a better combustion. Self-cleaning material.*



#### **CRISTAL PANORÁMICO** **PANORAMIC GLASS**

Gran cristal panorámico para disfrutar de todo el espectáculo del fuego. Sistema cristal limpio para una visión perfecta de las llamas.

Puerta reversible y reforzada.

*Large panoramic glass to enjoy all the beauty of the fire. Clean glass system for a perfect view of the flames.*

*Reversible and reinforced door.*



#### **REGULACIÓN** **AIR FLOW REGULATION**

Entradas de aire primario y secundario regulables.

*Adjustable primary and secondary air intakes.*



#### **OPCIONAL TAPA SUPERIOR EN CRISTAL** **OPTIONAL TOP GLASS**

Resalte el diseño de su estufa con la versión cristal. Puede elegir opcionalmente una elegante y moderna tapa de cristal vitrocerámico para decorar la parte superior de la estufa.

*Highlight the design of your stove with the glass version.*

*You can choose the option of an elegant modern ceramic glass top for decorating the upper part of your stove.*

# MAIA

De línea esbelta y cuidada  
*With a fine and slim design*

- Estufa de línea esbelta y cuidada, disponible en versión ROUND, LARGE, WALL o CUBE.
- Entradas de aire primario y secundario regulables para un control total en la combustión.
- Sistema de doble deflector.
- Stove with a fine and slim design, available in ROUND, LARGE, WALL or CUBE version.
- Primary and secondary adjustable air intakes for a complete control of the combustion.
- Double baffle system.

Modelo con doble cámara  
*Double chambre unit*



Sistema de regulación de aire secundario  
*Secondary air intake adjustment*

## MAIA ROUND

- Rendimiento 81%.
- Cámara de combustión en Vermiculita.
- Atractivo diseño redondeado.
- Dispone de un discreto compartimento con puerta en la parte inferior.
- Efficiency rate of 81%.
- Interior lining in Vermiculite.
- Attractive rounded design.
- With a discreet compartment with door at the bottom.

A+



Modelo con doble cámara  
*Double chambre unit*



**MAIA LARGE**

- Rendimiento 81%.
- Cámara de combustión en Vermiculita.
- Moderna y minimalista.
- De líneas rectas.

- *Efficiency rate of 81%.*
- *Interior lining in Vermiculite.*
- *Modern and minimalist.*
- *Designed on straight lines.*



Modelo con doble cámara  
*Double chambre unit*



Patas opcionales  
*Optional feet*

**MAIA WALL** (Opcional versión suspendida o con patas / *Optional suspended or with legs version*)

- Rendimiento 81%.
- Cámara de combustión en Vermiculita.
- Opcionalmente se puede montar con un juego de patas.
- Disponible también la opción de suspender el modelo a la pared.

- *Efficiency rate of 81%.*
- *Interior lining in Vermiculite.*
- *Optionally the Maia Wall can be installed with a set of feet.*
- *Also available the option to hang this model on the wall.*





**MAIA CUBE**

- Rendimiento 81%.
- Cámara de combustión en Vermiculita.
- Moderna y minimalista.
- Diseño en vertical que mejora la combustión.

- *Efficiency rate of 81%.*
- *Interior lining in Vermiculite.*
- *Modern and minimalist.*
- *Vertical design to boost combustion.*



**SISTEMA DE REGULACIÓN DE AIRE SECUNDARIO  
SECONDARY AIR INTAKE ADJUSTMENT**

Entrada de aire secundario regulable para un control total en la combustión.

*Adjustable secondary air intake for a total control of the combustion.*

# ATENEA

## Gran visión del fuego

### *Stove that offers an excellent view of the fire*

- Estufa con gran visión del fuego gracias a su amplia cámara de combustión.
  - Entradas de aire primario y secundario regulables para un control total en la combustión.
  - Sistema de doble deflector.
- *A stove that offers an excellent view of the fire, thanks to its large combustion chamber.*
  - *Primary and secondary adjustable air intakes for complete control over burning.*
  - *Double baffle system.*



Sistema de regulación de aire secundario  
*Secondary air intake adjustment*

#### ATENEA

- Rendimiento 80%.
  - Cámara de combustión en Vermiculita.
  - Diseño moderno y minimalista.
  - Cristal panorámico.
- *Efficiency rate of 80%.*
  - *Interior lining in Vermiculite.*
  - *Modern and minimalist design.*
  - *Panoramic glass.*



# ATLAS

## La evolución en las estufas con horno *An evolution in wood stoves with oven*

- Horno y hogar de gran capacidad.
  - Mínimas emisiones de CO del 0,03%.
  - Modelo de alto rendimiento.
  - Cámara de combustión de Thermic.
  - Entrada de aire exterior opcional para la combustión.
- *Large-capacity stove and fireplace.*
  - *Minimum CO emissions at 0,03%.*
  - *High efficiency model.*
  - *Interior lining in Thermic.*
  - *Optional exterior air intake.*



Incluye deflector desmontable  
antirrevoco  
*Includes removable front baffle*

### ATLAS

- Rendimiento 84%.
  - Opcional sistema de ventilación de 360 m<sup>3</sup>/h. mediante dos ventiladores de dos velocidades y termostato de seguridad.
- *Efficiency rate of 84%.*
  - *Optional 360 m<sup>3</sup>/h. powered fan system, with two 2-speed fans and safety thermostat.*

A+



# ATLAS

## Versión de rincón *Corner version*

- Horno y hogar de gran capacidad.
  - Mínimas emisiones de CO del 0,03%.
  - Modelo de alto rendimiento.
  - Cámara de combustión de Thermic.
  - Entrada de aire exterior opcional para la combustión.
- *Large-capacity stove and fireplace.*
  - *Minimum CO emissions at 0,03%.*
  - *High efficiency model.*
  - *Interior lining in Thermic.*
  - *Optional exterior air intake.*



Opcional versión rincón  
*Optional corner version*

### ATLAS (Versión de rincón / corner version)

- Rendimiento 84%.
  - Opcional sistema de ventilación de 360 m<sup>3</sup>/h. mediante dos ventiladores de dos velocidades y termostato de seguridad.
- *Efficiency rate of 84%.*
  - *Optional 360 m<sup>3</sup>/h. powered fan system, with two 2-speed fans and safety thermostat.*

A+



# ATLAS INSERTABLE / INSET

Canalizable y con opción de ventiladores  
*Possibility of fan-driven hot air channelling*

- Modelo insertable con opción de canalizar el aire caliente a otras habitaciones. Con salida de aire por el frontal.
- Marco de 4 lados.
- Cámara de combustión de Thermic.
- Entrada de aire exterior opcional para la combustión.
- Inset model that offers the option of ducting the hot air to other rooms. With front hot air outlets.
- 4-sided frame.
- Interior lining in Thermic.
- Optional exterior air intake.



Incluye deflector desmontable  
antirrevoco  
*Includes removable front baffle*

## ATLAS INSERTABLE / INSERT

- Rendimiento 84%.
- Opcional sistema de ventilación de 360 m<sup>3</sup>/h. mediante dos ventiladores de dos velocidades y termostato de seguridad.
- Efficiency rate of 84%.
- Optional 360 m<sup>3</sup>/h. powered fan system, with two 2-speed fans and safety thermostat.

A+





ATLAS

## Características *Features*



### **HORNO DE GRAN CAPACIDAD Y DESMONTABLE LARGE CAPACITY OVEN, DISMOUNTABLE**

Horno superior de gran tamaño en acero inoxidable con base de refractario y termómetro.

*Superior oven in stainless steel with a refractory base and thermometer.*



### **GRAN CÁMARA DE COMBUSTIÓN LARGE COMBUSTION CHAMBER**

Cámara de combustión muy espaciosa, revestida en acero y THERMIC para mejorar el funcionamiento y el rendimiento energético.

*Very spacious combustion chamber lined with steel and THERMIC for improved operation and energy performance.*



### **REGISTRO PARA LIMPIEZA CLEANING OPENING**

Incorpora un práctico registro para la limpieza de la cámara superior del horno.

*Includes a practical opening for cleaning the upper chamber of the oven.*



### **REGISTRO DE ACCESO PARA EL DESHOLLINADO CLEANING HATCH FOR CHIMNEY SWEEPING**

Registro de acceso para el deshollinado del conducto de humos.

*Cleaning hatch for maintenance.*

# HERMES

## Estética y discreta *Aesthetic and discreet*

- Disfrute de todas las ventajas en un tamaño más discreto.
  - Nuevo sistema de combustión que mejora el rendimiento hasta un 88% y reduce las emisiones de CO al 13% de O<sub>2</sub> hasta un 0,11%.
  - Cámara de combustión en Vermiculita.
  - Registro de acceso para el deshollinado.
- *Small size, yet great performance.*
  - *Efficiency 88%.*
  - *Minimum emissions of 0,11%.*
  - *Interior lining in Vermiculite.*
  - *Cleaning hatch for chimney sweeping.*



### NUEVO DISEÑO

Registro de acceso  
para el deshollinado  
*Cleaning hatch for  
chimney sweeping*

#### HERMES

- Rendimiento 88%.
  - Opcional sistema de ventilación de 360 m<sup>3</sup>/h. mediante dos ventiladores de dos velocidades y termostato de seguridad.
- *Efficiency rate of 88%.*
  - *Optional 360 m<sup>3</sup>/h. powered fan system, with two 2-speed fans and safety thermostat.*

A+





Opcional versión rincón  
Optional corner version

**HERMES (Versión de rincón / corner version)**

- Rendimiento 88%.
- Opcional sistema de ventilación de 360 m<sup>3</sup>/h. mediante dos ventiladores de dos velocidades y termostato de seguridad.

- Efficiency rate of 88%.
- Optional 360 m<sup>3</sup>/h. powered fan system, with two 2-speed fans and safety thermostat.



HERMES

**Características**  
*Features*



Horno superior en acero con termómetro. Incluye bandeja para el horno.

*Upper steel oven with thermometer. Includes tray for the oven.*



Cámara de combustión de acero y Vermiculita.

*Steel and Vermiculite combustion chamber.*

CARACTERÍSTICAS  
TÉCNICAS

TECHNICAL  
SPECIFICATIONS

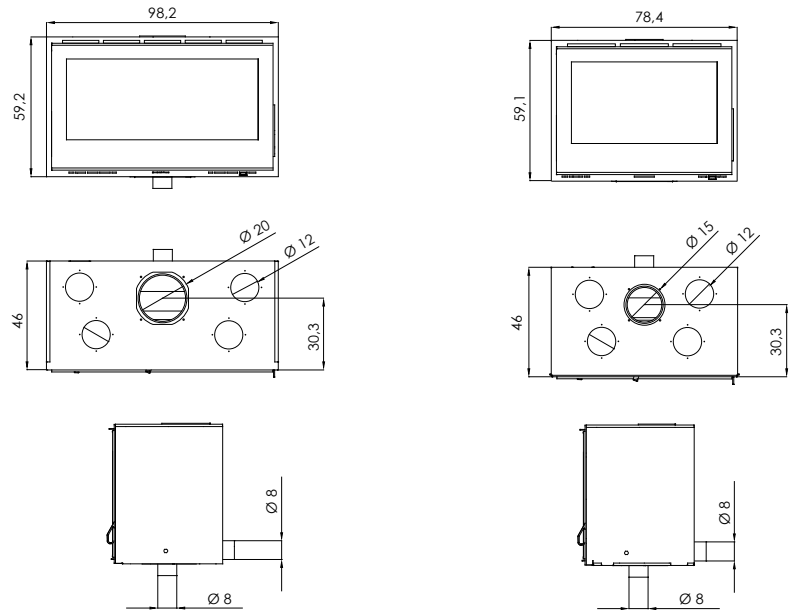

	I-100	I-80
Potencia <i>Output</i>	7 kW. - 16 kW.	7 kW. - 13 kW.
Potencia nominal: <i>Nominal Output</i>	10,78 kW.	9,48 kW.
Rendimiento <i>Efficiency</i>	87,3 %	85,09 %
Emisiones CO al 13% O <sub>2</sub> (mg/m <sup>3</sup> al 13% O <sub>2</sub> ) <i>Emission CO 13% O<sub>2</sub> (mg/m<sup>3</sup> at 13% O<sub>2</sub>)</i>	0,08 % (1118,45 mg/m <sup>3</sup> )	0,09 % - (1204,04 mg/m <sup>3</sup> )
Emisión de partículas al 13% O <sub>2</sub> <i>Particle emission at 13% O<sub>2</sub></i>	19,28 mg/m <sup>3</sup>	19,28 mg/m <sup>3</sup>
CnHm - OGC (mg/m <sup>3</sup> )	36,64 mg/m <sup>3</sup>	69,7 mg/m <sup>3</sup>
Nox mg/m <sup>3</sup>	74,39 mg/m <sup>3</sup>	74,39 mg/m <sup>3</sup>
Sistema de deflectores ajustables <i>Adjustable Baffle system</i>	✓	✓
Entradas de aire primario, secundario y terciario <i>Primary, secondary, and tertiary air supply</i>	✓	✓
Sistema cristal limpio: <i>Air- Wash system</i>	✓	✓
Entrada de aire exterior <i>External air Supply</i>	✓	✓
Modelo estanco <i>Airtight</i>	-	-
Cajón cenicero <i>Ash pan</i>	✓	✓
Revestimiento interior <i>Interior lining</i>	Vermiculita / Thermic	Vermiculita / Thermic
Peso <i>Weight</i>	129 / 133 Kg.	108 / 112 Kg.
Certificaciones <i>Certifications</i>	EN 16510 / EN 13229 / CE ECODESIGN / Stufe 2	EN 16510 / EN 13229 / CE ECODESIGN / Stufe 2
Clasificación energética <i>Energy label</i>	A+	A+

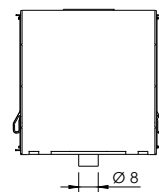
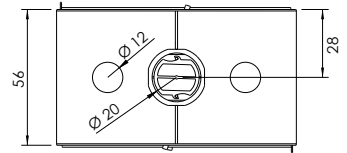
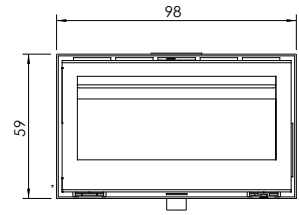
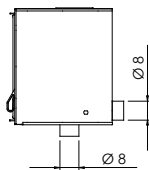
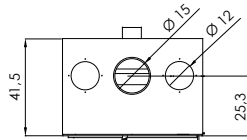
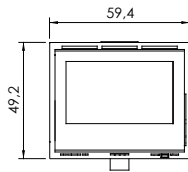
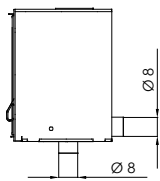
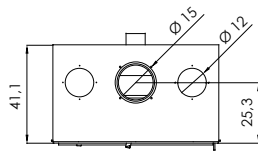
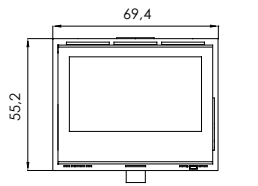

I-70	I-60	I-100 DOBLE CARA I-100 DOUBLE-SIDED
6 kW. - 12 kW.	4 kW. - 10 kW.	9 kW. - 17 kW.
8,18 kW.	6,2 kW.	12,6 kW.
85,09 %	81 %	77,9 %
0,09 % - (1204,04 mg/m <sup>3</sup> )	0,09 % - (1186,06 mg/m <sup>3</sup> )	0,086 % - (1074 mg/m <sup>3</sup> )
18,39 mg/m <sup>3</sup>	16,7 mg/m <sup>3</sup>	8 mg/m <sup>3</sup>
69,7 mg/m <sup>3</sup>	14,39 mg/m <sup>3</sup>	52 mg/m <sup>3</sup>
72,03 mg/m <sup>3</sup>	113,25 mg/m <sup>3</sup>	79 mg/m <sup>3</sup>
✓	✓	✓
✓	✓	✓
✓	✓	✓
✓	✓	✓
-	-	-
✓	-	✓
Vermiculita / Thermic	Vermiculita / Thermic	Vermiculita
88 / 91 Kg.	66 / 69 Kg.	153 Kg.
EN 16510 / EN 13229 / CE ECODESIGN / Stufe 2	EN 16510 / EN 13229 / CE ECODESIGN / Stufe 2	EN 16510 / EN 13229 / CE ECODESIGN / Stufe 2 / 15a B-VG / LRV



CARACTERÍSTICAS  
TÉCNICAS

TECHNICAL  
SPECIFICATIONS

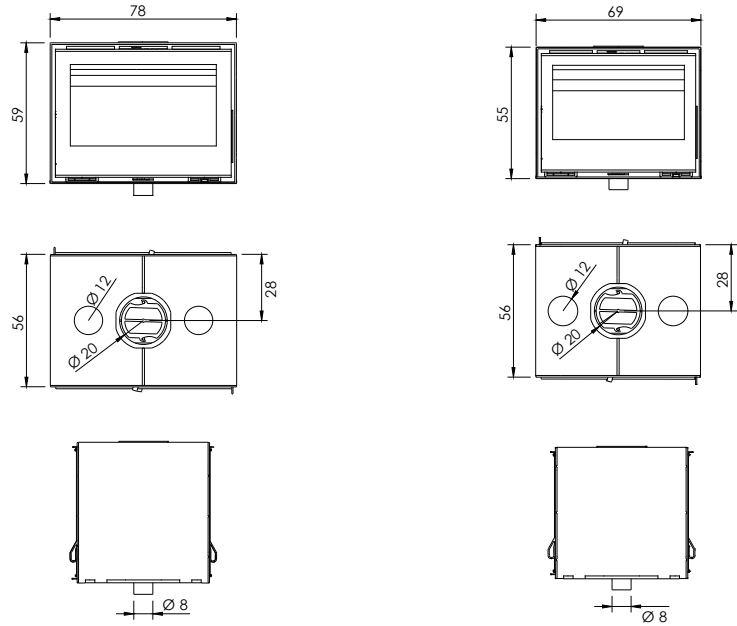

	<b>I-80 DOBLE CARA</b> <b>I-80 DOUBLE-SIDED</b>	<b>I-70 DOBLE CARA</b> <b>I-70 DOUBLE-SIDED</b>
Potencia <i>Output</i>	7 kW. - 16 kW.	6 kW. - 15 kW.
Potencia nominal: <i>Nominal Output</i>	11,3 kW.	10 kW.
Rendimiento <i>Efficiency</i>	77,9 %	81,6 %
Emissiones CO al 13% O <sub>2</sub> (mg/m <sup>3</sup> al 13% O <sub>2</sub> ) <i>Emission CO 13% O<sub>2</sub> (mg/m<sup>3</sup> at 13% O<sub>2</sub>)</i>	0,086 % - (1074 mg/m <sup>3</sup> )	0,06 % - (842 mg/m <sup>3</sup> )
Emisión de partículas al 13% O <sub>2</sub> <i>Particle emission at 13% O<sub>2</sub></i>	11 mg/m <sup>3</sup>	11 mg/m <sup>3</sup>
CnHm - OGC (mg/m <sup>3</sup> )	52 mg/m <sup>3</sup>	51 mg/m <sup>3</sup>
Nox mg/m <sup>3</sup>	89 mg/m <sup>3</sup>	89 mg/m <sup>3</sup>
Sistema de deflectores ajustables <i>Adjustable Baffle system</i>	✓	✓
Entradas de aire primario, secundario y terciario <i>Primary, secondary, and tertiary air supply</i>	✓	✓
Sistema cristal limpio: <i>Air- Wash system</i>	✓	✓
Entrada de aire exterior <i>External air Supply</i>	✓	✓
Modelo estanco <i>Airtight</i>	-	-
Cajón cenicero <i>Ash pan</i>	✓	✓
Revestimiento interior <i>Interior lining</i>	Vermiculita	Vermiculita
Peso <i>Weight</i>	129 Kg.	118 Kg.
Certificaciones <i>Certifications</i>	EN 16510 / EN 13229 / CE ECODESIGN / Stufe 2 / 15a B-VG / LRV	EN 16510 / EN 13229 / CE ECODESIGN / Stufe 2 / 15a B-VG / LRV
Clasificación energética <i>Energy label</i>	A	A+

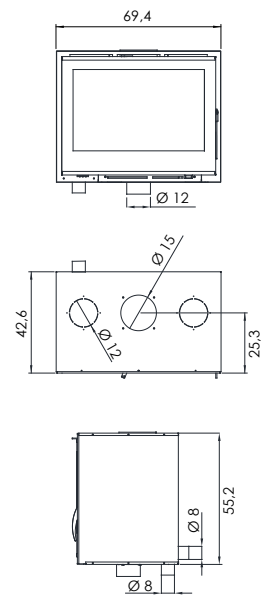
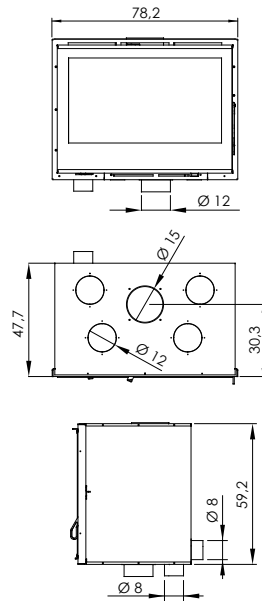
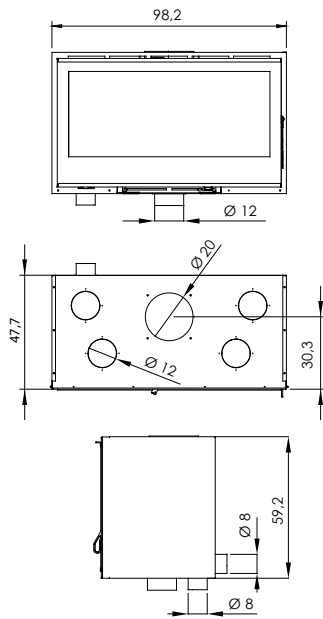

T2-100	T2-80	T2-70
7 kW. - 16 kW.	7 kW. - 13 kW.	6 kW. - 12 kW.
10,78 kW.	9,48 kW.	8,18 kW.
87,3 %	85,09 %	85,09 %
0,08 % - (1118,45 mg/m <sup>3</sup> )	0,09 % - (1204,04 mg/m <sup>3</sup> )	0,09 % - (1204,04 mg/m <sup>3</sup> )
19,28 mg/m <sup>3</sup>	19,28 mg/m <sup>3</sup>	18,39 mg/m <sup>3</sup>
36,64 mg/m <sup>3</sup>	69,7 mg/m <sup>3</sup>	69,7 mg/m <sup>3</sup>
74,39 mg/m <sup>3</sup>	74,39 mg/m <sup>3</sup>	72,03 mg/m <sup>3</sup>
✓	✓	✓
✓	✓	✓
✓	✓	✓
✓	✓	✓
-	-	-
-	-	-
Vermiculita	Vermiculita	Vermiculita
127 Kg.	109 Kg.	85 Kg.
EN 16510 / EN 13229 / CE ECODESIGN / Stufe 2	EN 16510 / EN 13229 / CE ECODESIGN / Stufe 2	EN 16510 / EN 13229 / CE ECODESIGN / Stufe 2



CARACTERÍSTICAS  
TÉCNICAS

TECHNICAL  
SPECIFICATIONS

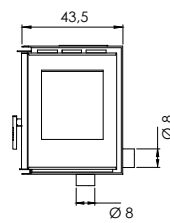
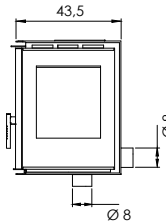
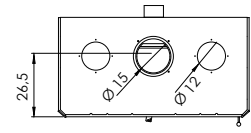
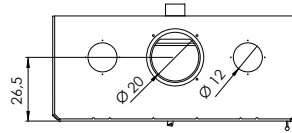
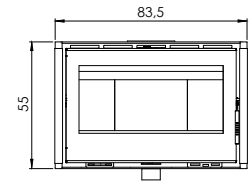
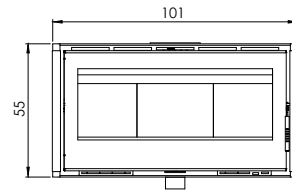

	<b>A-100-2</b>	<b>A-85-2</b>
Potencia <i>Output</i>	7 kW. - 15 kW.	6 kW. - 13 kW.
Potencia nominal: <i>Nominal Output</i>	10,9 kW.	9,4 kW.
Rendimiento <i>Efficiency</i>	78 %	75 %
Emisiones CO al 13% O <sub>2</sub> (mg/m <sup>3</sup> al 13% O <sub>2</sub> ) <i>Emission CO 13% O<sub>2</sub> (mg/m<sup>3</sup> at 13% O<sub>2</sub>)</i>	0,07 % - (912 mg/m <sup>3</sup> )	0,11 % - (1342 mg/m <sup>3</sup> )
Emisión de partículas al 13% O <sub>2</sub> <i>Particle emission at 13% O<sub>2</sub></i>	9 mg/m <sup>3</sup>	15 mg/m <sup>3</sup>
CnHm - OGC (mg/m <sup>3</sup> )	45 mg/m <sup>3</sup>	84 mg/m <sup>3</sup>
Nox mg/m <sup>3</sup>	98 mg/m <sup>3</sup>	98 mg/m <sup>3</sup>
Sistema de deflectores ajustables <i>Adjustable Baffle system</i>	✓	✓
Entradas de aire primario, secundario y terciario <i>Primary, secondary, and tertiary air supply</i>	✓	✓
Sistema cristal limpio: <i>Air- Wash system</i>	✓	✓
Entrada de aire exterior <i>External air Supply</i>	✓	✓
Modelo estanco <i>Airtight</i>	-	-
Cajón cenicero <i>Ash pan</i>	✓	✓
Revestimiento interior <i>Interior lining</i>	Thermic	Thermic
Peso <i>Weight</i>	122 Kg.	103 Kg.
Certificaciones <i>Certifications</i>	EN 16510 / EN 13229 / CE ECODESIGN / Stufe 2	EN 16510 / EN 13229 / CE ECODESIGN
Clasificación energética <i>Energy label</i>	A	A



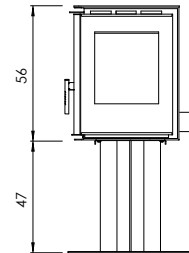
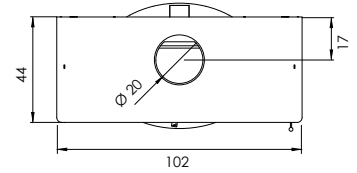
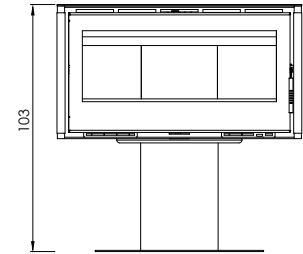
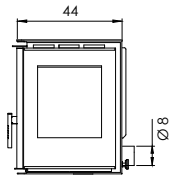
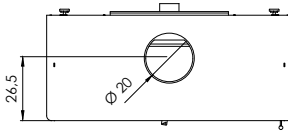
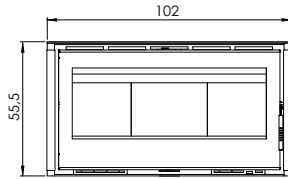
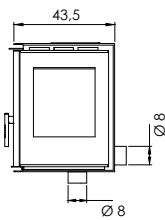
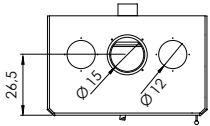
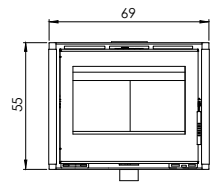

<b>A-70-2</b>	<b>RA-100-2</b>	<b>RA-100-2 PIE RA-100-2 FREE-STANDING</b>
5 kW. - 12 kW.	7 kW. - 15 kW.	7 kW. - 15 kW.
7,8 kW.	10,9 kW.	10,9 kW.
75 %	78 %	78 %
0,11 % - (1342 mg/m <sup>3</sup> )	0,07 % - (912 mg/m <sup>3</sup> )	0,07 % - (912 mg/m <sup>3</sup> )
15 mg/m <sup>3</sup>	9 mg/m <sup>3</sup>	9 mg/m <sup>3</sup>
84 mg/m <sup>3</sup>	45 mg/m <sup>3</sup>	45 mg/m <sup>3</sup>
94 mg/m <sup>3</sup>	98 mg/m <sup>3</sup>	98 mg/m <sup>3</sup>
✓	✓	✓
✓	✓	✓
✓	✓	✓
✓	✓	✓
-	-	-
✓	✓	✓
Thermic	Thermic	Thermic
90 Kg.	149 Kg.	171 Kg.
EN 16510 / EN 13229 / CE ECODESIGN	EN 16510 / EN 13240 / CE ECODESIGN / Stufe 2	EN 16510 / EN 13240 / CE ECODESIGN / Stufe 2



CARACTERÍSTICAS  
TÉCNICAS

TECHNICAL  
SPECIFICATIONS

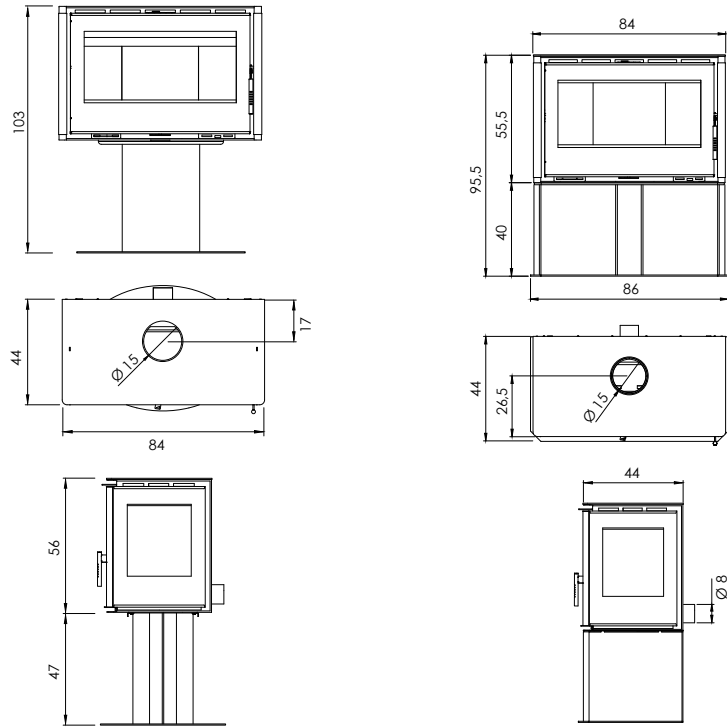

	<b>RA-85-2 PIE</b> <b>RA-85-2 FREE-STANDING</b>	<b>RA-85-2 LEÑERA</b> <b>RA-85-2 WITH LOG STORE</b>
Potencia <i>Output</i>	6 kW. - 13 kW.	6 kW. - 13 kW.
Potencia nominal: <i>Nominal Output</i>	9,4 kW.	9,4 kW.
Rendimiento <i>Efficiency</i>	75 %	75 %
Emisiones CO al 13% O <sub>2</sub> (mg/m <sup>3</sup> al 13% O <sub>2</sub> ) <i>Emission CO 13% O<sub>2</sub> (mg/m<sup>3</sup> at 13% O<sub>2</sub>)</i>	0,11 % - (1342 mg/m <sup>3</sup> )	0,11 % - (1342 mg/m <sup>3</sup> )
Emisión de partículas al 13% O <sub>2</sub> <i>Particle emission at 13% O<sub>2</sub></i>	15 mg/m <sup>3</sup>	15 mg/m <sup>3</sup>
CnHm - OGC (mg/m <sup>3</sup> )	84 mg/m <sup>3</sup>	84 mg/m <sup>3</sup>
Nox mg/m <sup>3</sup>	98 mg/m <sup>3</sup>	98 mg/m <sup>3</sup>
Sistema de deflectores ajustables <i>Adjustable Baffle system</i>	✓	✓
Entradas de aire primario, secundario y terciario <i>Primary, secondary, and tertiary air supply</i>	✓	✓
Sistema cristal limpio: <i>Air- Wash system</i>	✓	✓
Entrada de aire exterior <i>External air Supply</i>	✓	✓
Modelo estanco <i>Airtight</i>	-	-
Cajón cenicero <i>Ash pan</i>	✓	✓
Revestimiento interior <i>Interior lining</i>	Thermic	Thermic
Peso <i>Weight</i>	154 Kg.	174 Kg.
Certificaciones <i>Certifications</i>	EN 16510 / EN 13240 / CE ECODESIGN	EN 16510 / EN 13240 / CE ECODESIGN
Clasificación energética <i>Energy label</i>	A	A

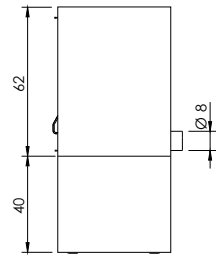
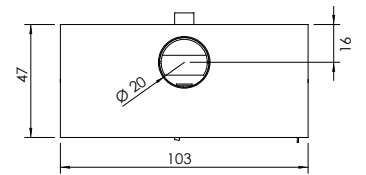
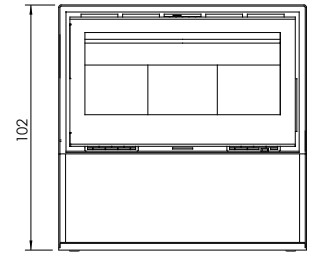
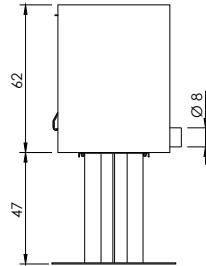
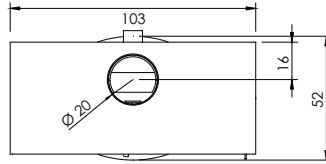
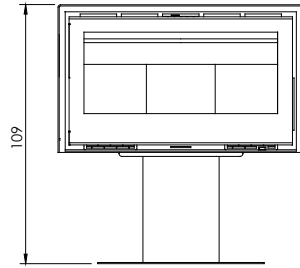
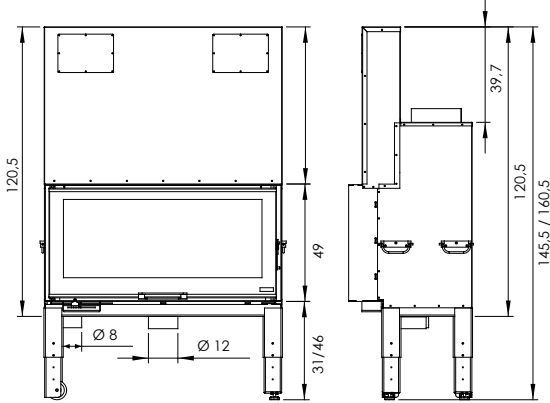
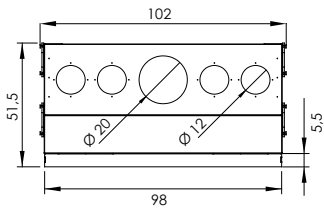

<b>G-100</b>	<b>RI-100 PIE RI-100 FREE-STANDING</b>	<b>RI-100 LEÑERA RI-100 WITH LOG STORE</b>
9 kW. - 17 kW.	7 kW. - 16 kW.	7 kW. - 16 kW.
15,4 kW.	10,78 kW.	10,78 kW.
76 %	87,3 %	87,3 %
0,08 % - (972,18 mg/m <sup>3</sup> )	0,08 % (1118,45 mg/m <sup>3</sup> )	0,08 % (1118,45 mg/m <sup>3</sup> )
12,7 mg/m <sup>3</sup>	19,28 mg/m <sup>3</sup>	19,28 mg/m <sup>3</sup>
15,92 mg/m <sup>3</sup>	36,64 mg/m <sup>3</sup>	36,64 mg/m <sup>3</sup>
124,59 mg/m <sup>3</sup>	74,39 mg/m <sup>3</sup>	74,39 mg/m <sup>3</sup>
✓	✓	✓
✓	✓	✓
✓	✓	✓
✓	✓	✓
-	-	-
-	✓	✓
Thermic	Vermiculita / Thermic	Vermiculita / Thermic
245 Kg.	207 / 219 Kg.	227 / 239 Kg.
EN 16510 / EN 13229 / CE ECODESIGN / Stufe 2	EN 16510 / EN 13240 / CE ECODESIGN / Stufe 2	EN 16510 / EN 13240 / CE ECODESIGN / Stufe 2



CARACTERÍSTICAS  
TÉCNICAS

TECHNICAL  
SPECIFICATIONS

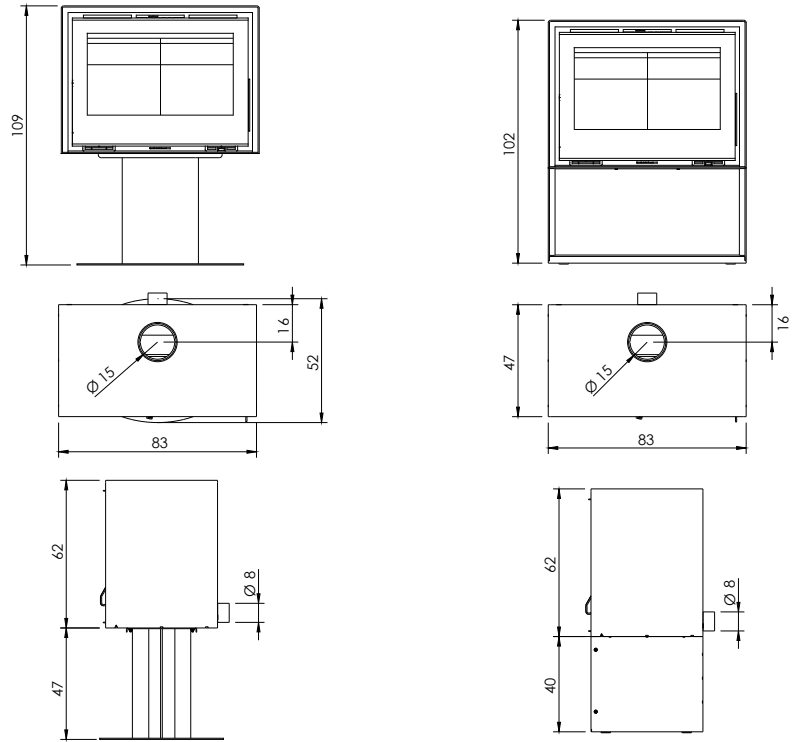

	<b>RI-80 PIE</b> <b>RI-80 FREE-STANDING</b>	<b>RI-80 LEÑERA</b> <b>RI-80 WITH LOG STORE</b>
Potencia <i>Output</i>	7 kW. - 13 kW.	7 kW. - 13 kW.
Potencia nominal: <i>Nominal Output</i>	9,48 kW.	9,48 kW.
Rendimiento <i>Efficiency</i>	85,09 %	85,09 %
Emisiones CO al 13% O <sub>2</sub> (mg/m <sup>3</sup> al 13% O <sub>2</sub> ) <i>Emission CO 13% O<sub>2</sub> (mg/m<sup>3</sup> at 13% O<sub>2</sub>)</i>	0,09 % - (1204,04 mg/m <sup>3</sup> )	0,09 % - (1204,04 mg/m <sup>3</sup> )
Emisión de partículas al 13% O <sub>2</sub> <i>Particle emission at 13% O<sub>2</sub></i>	19,28 mg/m <sup>3</sup>	19,28 mg/m <sup>3</sup>
CnHm - OGC (mg/m <sup>3</sup> )	69,7 mg/m <sup>3</sup>	69,7 mg/m <sup>3</sup>
Nox mg/m <sup>3</sup>	74,39 mg/m <sup>3</sup>	74,39 mg/m <sup>3</sup>
Sistema de deflectores ajustables <i>Adjustable Baffle system</i>	✓	✓
Entradas de aire primario, secundario y terciario <i>Primary, secondary, and tertiary air supply</i>	✓	✓
Sistema cristal limpio: <i>Air- Wash system</i>	✓	✓
Entrada de aire exterior <i>External air Supply</i>	✓	✓
Modelo estanco <i>Airtight</i>	-	-
Cajón cenicero <i>Ash pan</i>	✓	✓
Revestimiento interior <i>Interior lining</i>	Vermiculita / Thermic	Vermiculita / Thermic
Peso <i>Weight</i>	174 / 189 Kg.	189 / 204 Kg.
Certificaciones <i>Certifications</i>	EN 16510 / EN 13240 / CE ECODESIGN / Stufe 2	EN 16510 / EN 13240 / CE ECODESIGN / Stufe 2
Clasificación energética <i>Energy label</i>	A+	A+

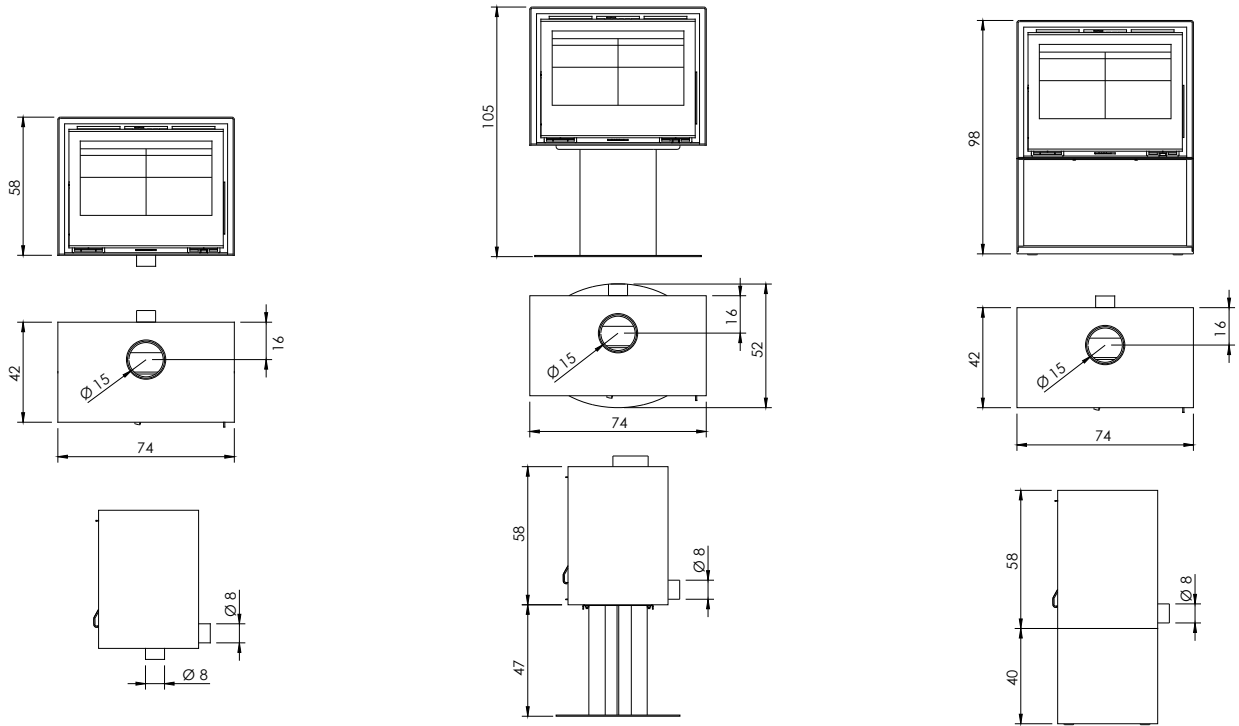

<b>RI-70</b>	<b>RI-70 PIE RI-70 FREE-STANDING</b>	<b>RI-70 LEÑERA RI-70 WITH LOG STORE</b>
6 kW. - 12 kW.	6 kW. - 12 kW.	6 kW. - 12 kW.
8,18 kW.	8,18 kW.	8,18 kW.
85,09 %	85,09 %	85,09 %
0,09 % - (1204,04 mg/m <sup>3</sup> )	0,09 % - (1204,04 mg/m <sup>3</sup> )	0,09 % - (1204,04 mg/m <sup>3</sup> )
18,39 mg/m <sup>3</sup>	18,39 mg/m <sup>3</sup>	18,39 mg/m <sup>3</sup>
69,7 mg/m <sup>3</sup>	69,7 mg/m <sup>3</sup>	69,7 mg/m <sup>3</sup>
72,03 mg/m <sup>3</sup>	72,03 mg/m <sup>3</sup>	72,03 mg/m <sup>3</sup>
✓	✓	✓
✓	✓	✓
✓	✓	✓
✓	✓	✓
-	-	-
✓	✓	✓
Vermiculita / Thermic	Vermiculita / Thermic	Vermiculita / Thermic
125 / 136 Kg.	147 / 158 Kg.	158 / 169 Kg.
EN 16510 / EN 13240 / CE ECODESIGN / Stufe 2	EN 16510 / EN 13240 / CE ECODESIGN / Stufe 2	EN 16510 / EN 13240 / CE ECODESIGN / Stufe 2

**A+**

**A+**

**A+**

CARACTERÍSTICAS  
TÉCNICAS

TECHNICAL  
SPECIFICATIONS

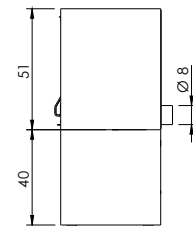
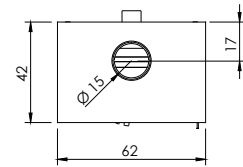
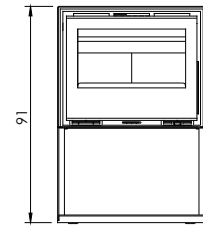
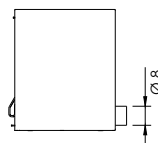
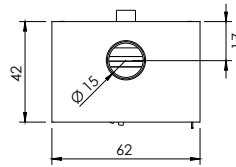
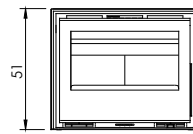

	RI-60	RI-60 LEÑERA RI-60 WITH LOG STORE
Potencia <i>Output</i>	4 kW. - 10 kW.	4 kW. - 10 kW.
Potencia nominal: <i>Nominal Output</i>	6,2 kW.	6,2 kW.
Rendimiento <i>Efficiency</i>	81 %	81 %
Emisiones CO al 13% O <sub>2</sub> (mg/m <sup>3</sup> al 13% O <sub>2</sub> ) <i>Emission CO 13% O<sub>2</sub> (mg/m<sup>3</sup> at 13% O<sub>2</sub>)</i>	0,09 % - (1186,06 mg/m <sup>3</sup> )	0,09 % - (1186,06 mg/m <sup>3</sup> )
Emisión de partículas al 13% O <sub>2</sub> <i>Particle emission at 13% O<sub>2</sub></i>	16,7 mg/m <sup>3</sup>	16,7 mg/m <sup>3</sup>
CnHm - OGC (mg/m <sup>3</sup> )	14,39 mg/m <sup>3</sup>	14,39 mg/m <sup>3</sup>
Nox mg/m <sup>3</sup>	113,25 mg/m <sup>3</sup>	113,25 mg/m <sup>3</sup>
Sistema de deflectores ajustables <i>Adjustable Baffle system</i>	✓	✓
Entradas de aire primario, secundario y terciario <i>Primary, secondary, and tertiary air supply</i>	✓	✓
Sistema cristal limpio: <i>Air- Wash system</i>	✓	✓
Entrada de aire exterior <i>External air Supply</i>	✓	✓
Modelo estanco <i>Airtight</i>	-	-
Cajón cenicero <i>Ash pan</i>	-	-
Revestimiento interior <i>Interior lining</i>	Vermiculita / Thermic	Vermiculita / Thermic
Peso <i>Weight</i>	93 / 100 Kg.	123 / 130 Kg.
Certificaciones <i>Certifications</i>	EN 16510 / EN 13240 / CE ECODESIGN / Stufe 2	EN 16510 / EN 13240 / CE ECODESIGN / Stufe 2
Clasificación energética <i>Energy label</i>	A+	A+

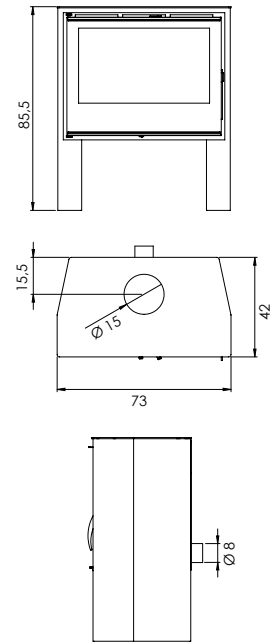
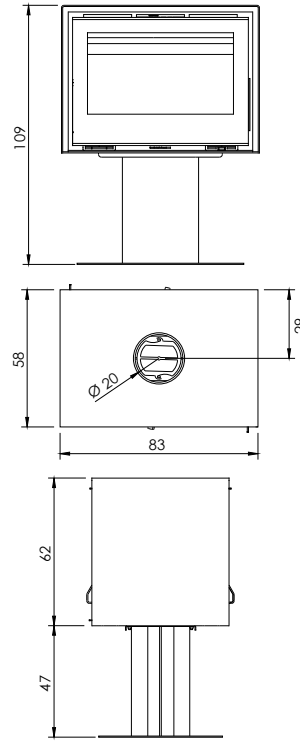
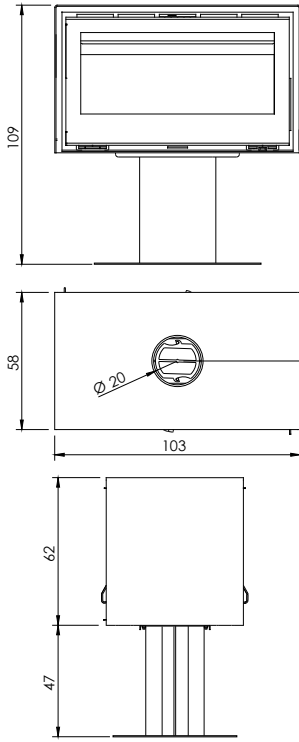

<b>RI-100 DOBLE CARA RI-100 DOUBLE-SIDED</b>	<b>RI-80 DOBLE CARA RI-80 DOUBLE-SIDED</b>	<b>ARES-2</b>
9 kW. - 17 kW.	7 kW. - 16 kW.	6 kW. - 12 kW.
12,6 kW.	11,3 kW.	8,18 kW.
77,9 %	77,9 %	85,09 %
0,086 % - (1074 mg/m <sup>3</sup> )	0,086 % - (1074 mg/m <sup>3</sup> )	0,09 % - (1204,04 mg/m <sup>3</sup> )
8 mg/m <sup>3</sup>	11 mg/m <sup>3</sup>	18,39 mg/m <sup>3</sup>
52 mg/m <sup>3</sup>	52 mg/m <sup>3</sup>	69,7 mg/m <sup>3</sup>
79 mg/m <sup>3</sup>	89 mg/m <sup>3</sup>	72,03 mg/m <sup>3</sup>
✓	✓	✓
✓	✓	✓
✓	✓	✓
✓	✓	✓
-	-	-
✓	✓	✓
Vermiculita	Vermiculita	Thermic
257 Kg.	222 Kg.	135 Kg.
EN 16510 / EN 13240 / CE ECODESIGN / Stufe 2 / 15a B-VG / LRV	EN 16510 / EN 13240 / CE ECODESIGN / Stufe 2 / 15a B-VG / LRV	EN 16510 / EN 13240 / CE ECODESIGN / Stufe 2



CARACTERÍSTICAS  
TÉCNICAS

TECHNICAL  
SPECIFICATIONS

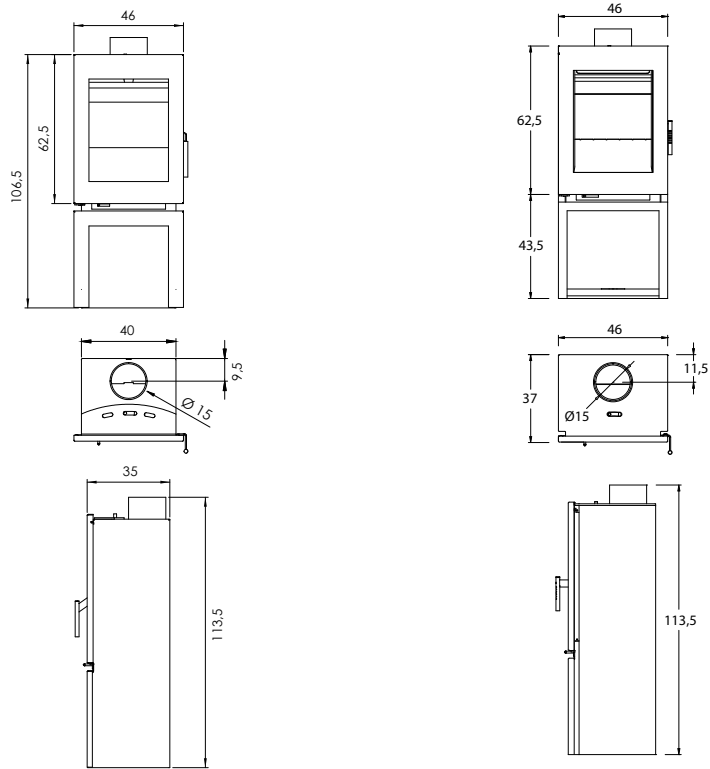

	MAIA CUBE	MAIA LARGE
Potencia <i>Output</i>	4 kW. - 11 kW.	4 kW. - 11 kW.
Potencia nominal: <i>Nominal Output</i>	7,18 kW.	7,18 kW.
Rendimiento <i>Efficiency</i>	80,95 %	80,95 %
Emisiones CO al 13% O <sub>2</sub> (mg/m <sup>3</sup> al 13% O <sub>2</sub> ) <i>Emission CO 13% O<sub>2</sub> (mg/m<sup>3</sup> at 13% O<sub>2</sub>)</i>	0,09% - (1081 mg/m <sup>3</sup> )	0,09% - (1081 mg/m <sup>3</sup> )
Emisión de partículas al 13% O <sub>2</sub> <i>Particle emission at 13% O<sub>2</sub></i>	17,1 mg/m <sup>3</sup>	17,1 mg/m <sup>3</sup>
CnHm - OGC (mg/m <sup>3</sup> )	73,75 mg/m <sup>3</sup>	73,75 mg/m <sup>3</sup>
Nox mg/m <sup>3</sup>	101,84 mg/m <sup>3</sup>	101,84 mg/m <sup>3</sup>
Sistema de deflectores ajustables <i>Adjustable Baffle system</i>	✓	✓
Entradas de aire primario, secundario y terciario <i>Primary, secondary, and tertiary air supply</i>	✓	✓
Sistema cristal limpio: <i>Air- Wash system</i>	✓	✓
Entrada de aire exterior <i>External air Supply</i>	-	-
Modelo estanco <i>Airtight</i>	-	-
Cajón cenicero <i>Ash pan</i>	✓	✓
Revestimiento interior <i>Interior lining</i>	Vermiculita	Vermiculita
Peso <i>Weight</i>	76 Kg.	84 Kg.
Certificaciones <i>Certifications</i>	EN 16510 / EN 13240 / CE ECODESIGN / Stufe 2	EN 16510 / EN 13240 / CE ECODESIGN / Stufe 2
Clasificación energética <i>Energy label</i>	A+	A+



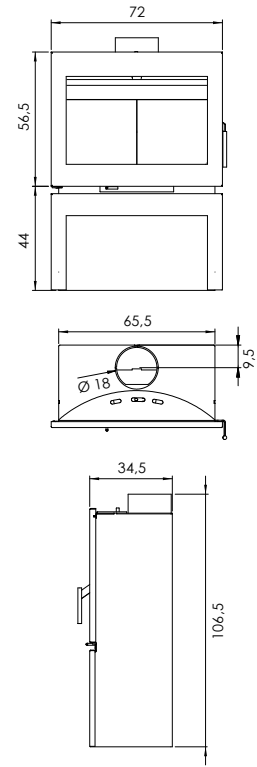
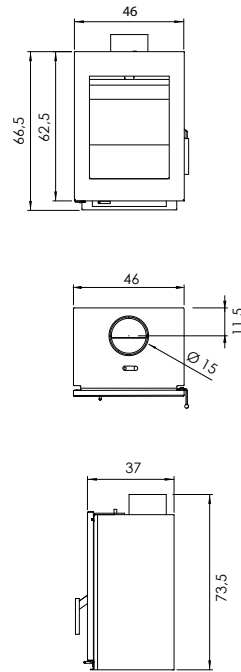
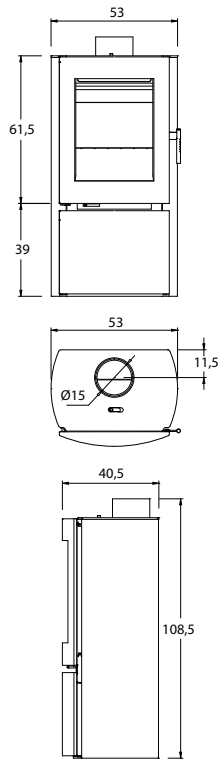

MAIA ROUND	MAIA WALL	ATENEA
4 kW. - 11 kW.	4 kW. - 11 kW.	5 Kw. - 12 Kw.
7,18 kW.	7,18 kW.	8,6 Kw.
80,95 %	80,95 %	80 %
0,09% - (1081 mg/m <sup>3</sup> )	0,09% - (1081 mg/m <sup>3</sup> )	0,11% - (1411 mg/m <sup>3</sup> )
17,1 mg/m <sup>3</sup>	17,1 mg/m <sup>3</sup>	13,70 mg/m <sup>3</sup>
73,75 mg/m <sup>3</sup>	73,75 mg/m <sup>3</sup>	44,39 mg/m <sup>3</sup>
101,84 mg/m <sup>3</sup>	101,84 mg/m <sup>3</sup>	39,17 mg/m <sup>3</sup>
✓	✓	✓
✓	✓	✓
✓	✓	✓
-	-	-
-	-	-
✓	✓	✓
Vermiculita	Vermiculita	Vermiculita
90 Kg.	76 Kg.	90 Kg.
EN 16510 / EN 13240 / CE ECODESIGN / Stufe 2	EN 16510 / EN 13240 / CE ECODESIGN / Stufe 2	EN 16510 / EN 13240 / CE ECODESIGN



CARACTERÍSTICAS  
TÉCNICAS

TECHNICAL  
SPECIFICATIONS

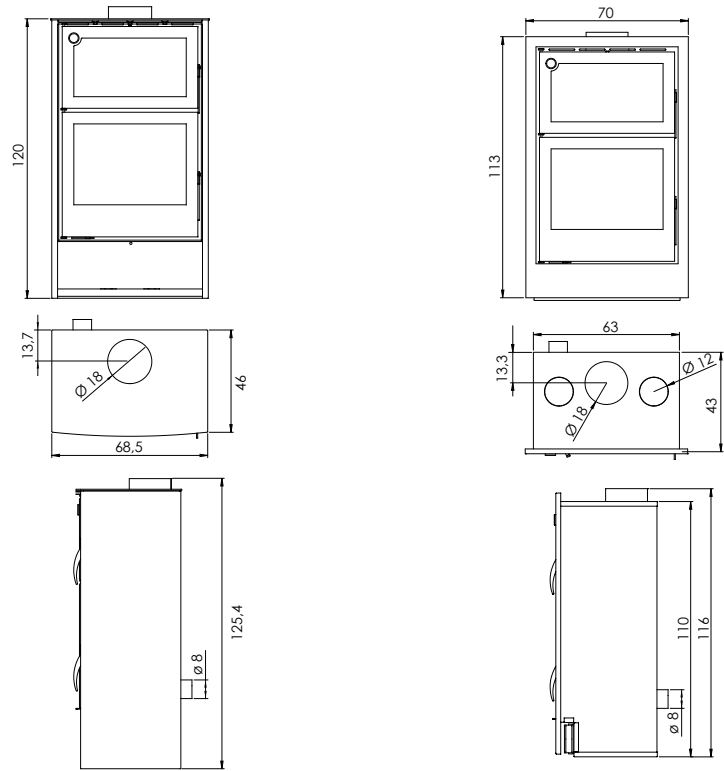

	ATLAS	ATLAS INSERTABLE ATLAS INSERT
Potencia <i>Output</i>	6 kW. - 12 kW.	6 kW. - 12 kW.
Potencia nominal: <i>Nominal Output</i>	10 kW.	10 kW.
Rendimiento <i>Efficiency</i>	84 %	84 %
Emissiones CO al 13% O <sub>2</sub> (mg/m <sup>3</sup> al 13% O <sub>2</sub> ) <i>Emission CO 13% O<sub>2</sub> (mg/m<sup>3</sup> at 13% O<sub>2</sub>)</i>	0,03% - (375 mg/m <sup>3</sup> )	0,03% - (375 mg/m <sup>3</sup> )
Emisión de partículas al 13% O <sub>2</sub> <i>Particle emission at 13% O<sub>2</sub></i>	30,8 mg/m <sup>3</sup>	30,8 mg/m <sup>3</sup>
CnHm - OGC (mg/m <sup>3</sup> )	57,5 mg/m <sup>3</sup>	57,5 mg/m <sup>3</sup>
Nox mg/m <sup>3</sup>	31 mg/m <sup>3</sup>	31 mg/m <sup>3</sup>
Sistema de deflectores ajustables <i>Adjustable Baffle system</i>	✓	✓
Entradas de aire primario, secundario y terciario <i>Primary, secondary, and tertiary air supply</i>	✓	✓
Sistema cristal limpio: <i>Air- Wash system</i>	✓	✓
Entrada de aire exterior <i>External air Supply</i>	✓	✓
Modelo estanco <i>Airtight</i>	-	-
Cajón cenicero <i>Ash pan</i>	✓	✓
Revestimiento interior <i>Interior lining</i>	Thermic	Thermic
Peso <i>Weight</i>	175 Kg.	130 Kg.
Certificaciones <i>Certifications</i>	EN 16510 / EN 13240 / CE ECODESIGN / Stufe 2	EN 16510 / EN 13229 / CE ECODESIGN / Stufe 2
Clasificación energética <i>Energy label</i>	A+	A+

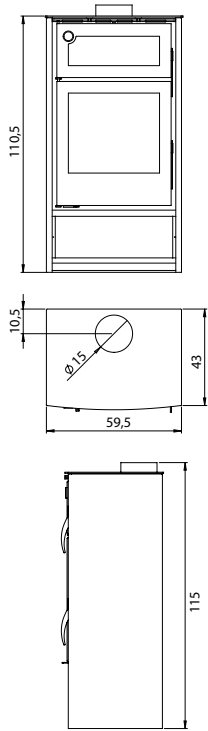

**DIFUSOR 4 TOMAS  
CONVECTION OUTLET x 4**

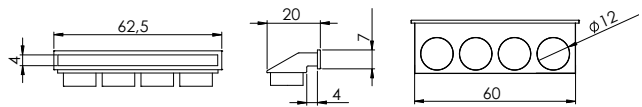

**DIFUSOR 2 TOMAS  
CONVECTION OUTLET x 2**

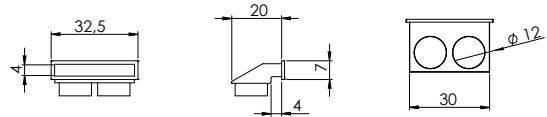

**BOX 180**

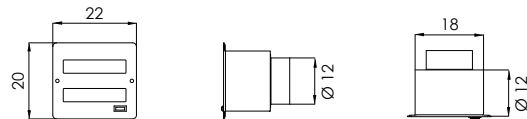

**BOX ECO SILENT**

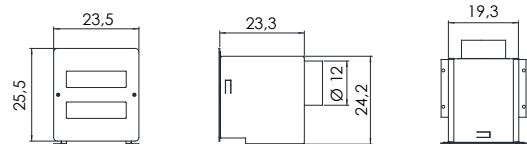

**HERMES**

5 kW. - 10 kW.

9 kW.

88 %

0,11% - (1443 mg/m<sup>3</sup>)

39,4 mg/m<sup>3</sup>

94,04 mg/m<sup>3</sup>

72,62 mg/m<sup>3</sup>



-

-



Vermiculita

125 Kg.

EN 16510 / EN 13240 / CE  
ECODESIGN





**Cocinas CARBEL, S.L.**  
Tel.: (+34) 96 134 07 16  
[www.carbel.net](http://www.carbel.net)  
[carbel@carbel.net](mailto:carbel@carbel.net)

¡Síguenos!  
Follow us!



El fabricante se reserva el derecho de introducir las modificaciones que estime necesarias en beneficio del producto y del cliente.  
*CARBEL reserves the right to alter designs and specification without notice.*

Distribuidor / Dealer: